

TECHNICAL DATA

ROLF BENZ 310



**ROLF
BENZ**

- Wooden inner frame
- Nosag spring support
- Back in polyurethane foam
- Seat in polyurethane foam, built up in coordinated layers varying in height and firmness
- Cover quilted underneath with non-woven polyester
- Brace metal optionally:
 - Stainless steel
 - Smooth steel, powder-coated, matt RAL 9017 traffic black

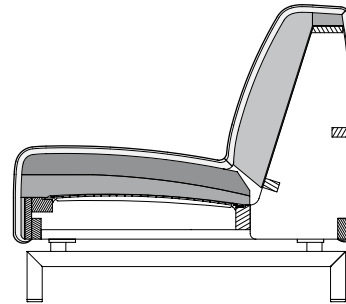

! Due to the way the furniture is designed, and its comfort level, some wrinkles and sitting pressure indentations are inevitable, even in top quality Rolf Benz upholstered furniture.
 All dimensions are approximate.

Seat heights available

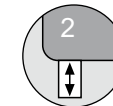

Sofa

Sofa

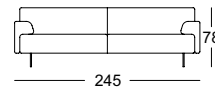
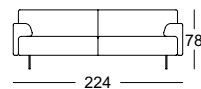
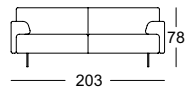
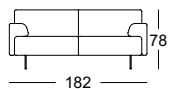

**ROLF
BENZ**

Sectional sofa*

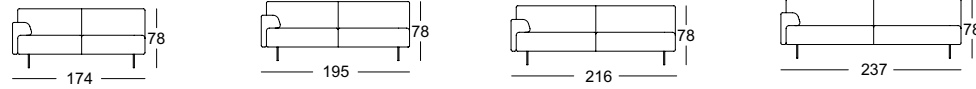

Corner modular sofa element*

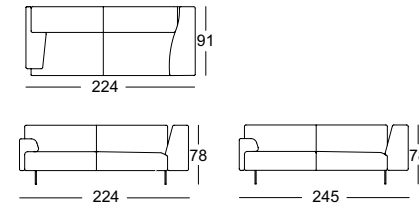

Corner sectional sofa*

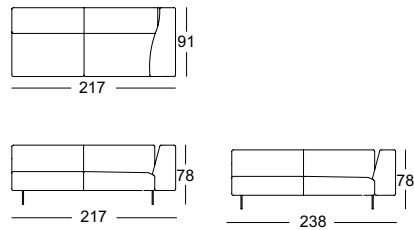

Sectional sofa with fixed footstool*

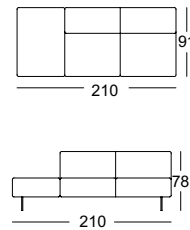

Corner sectional sofa with fixed footstool*

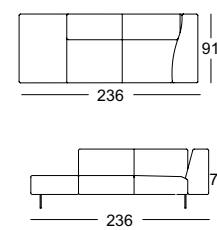

Upholstered bench

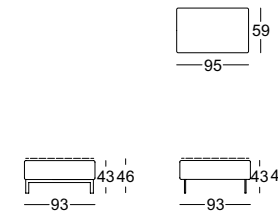

Combination examples:

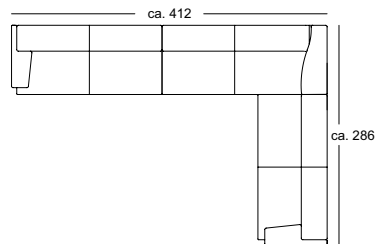

ASO 310/195 le.
E-ARB 310/217 le.
ASO 310/195 ri.

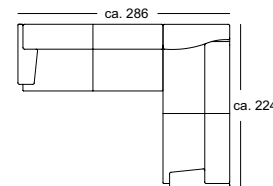

ASO 310/195 ri.
E-ASO 3140/224 le.

*These elements are only shown in the left version. They are also available in the right version.