

TECHNICAL DATA

# ROLF BENZ 328

---



**ROLF  
BENZ**

- Wooden inner frame
- Nosag spring support
- Back in polyurethane foam
- Seat in polyurethane foam, built up in coordinated layers varying in height and firmness
- Cover quilted underneath with non-woven polyester
- Metal runner optionally:
  - Fine-grain steel, powder-coated, matt silver
  - Fine-grain steel, powder-coated, matt RAL 9017 Traffic black
  - Fine-grain steel, powder-coated, matt RAL 7022 Umbra grey

! Wave formation and depressions in the seat area are unavoidable, due to comfort and design reasons, even in high quality Rolf Benz upholstered furniture.

All measurements are approximate.

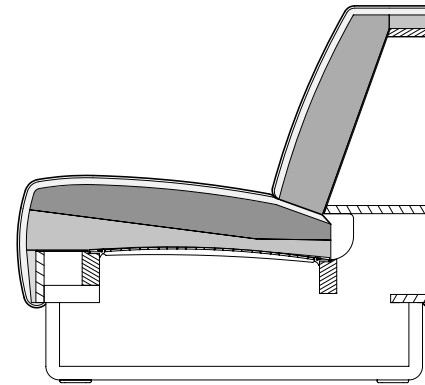

Seat heights available

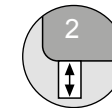

Armchair

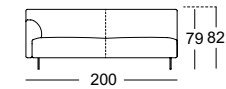
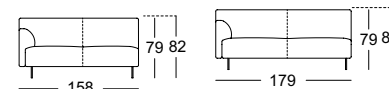
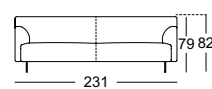
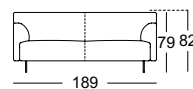
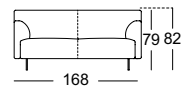
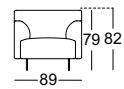
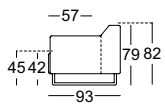

Sectional sofa\*

Closing chair with fixed footstool\*

Corner sectional sofa\*

Sectional sofa with fixed footstool\*

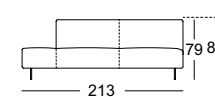
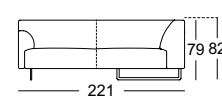
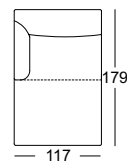
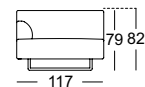
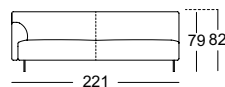

**ROLF  
BENZ**

Corner sectional sofa  
with fixed footstool\*

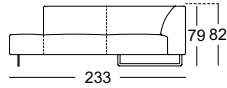

High backed  
armchair

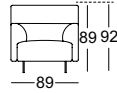

High-backed  
sofa

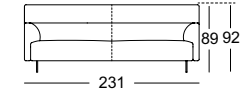
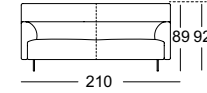
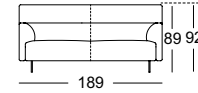
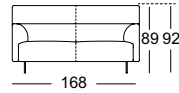

High-backed  
sectional  
sofa

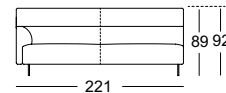
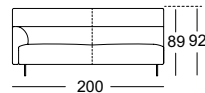
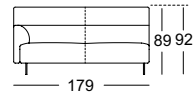
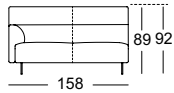

High backed  
closing  
chair with  
fixed footstool\*

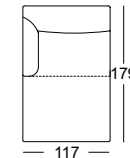
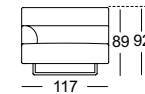

High-backed corner  
sectional sofa\*

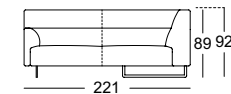

High-backed section-  
al sofa with fixed  
footstool\*

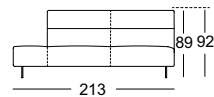

High-backed  
corner  
sectional sofa  
with fixed footstool\*

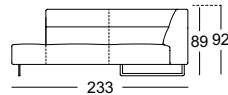

Footstool

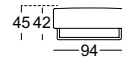
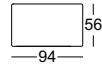

\*These elements are only shown in the left version. They are also available in the right version.

Combination examples.

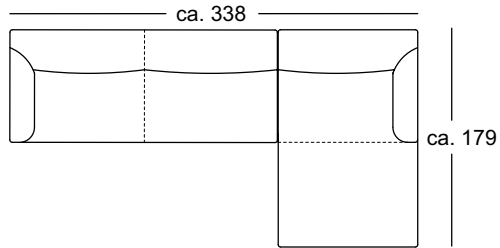

H-ASO 328/221 le.  
H-ASS-PSZ 328/117 ri.

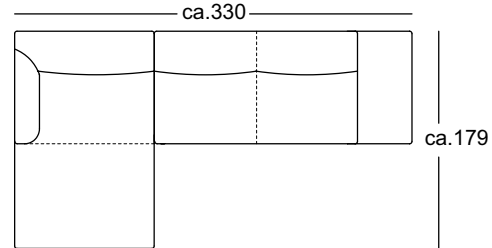

ASS-PSZ 328/117 le.  
ARB-PSZ 328/213 ri.

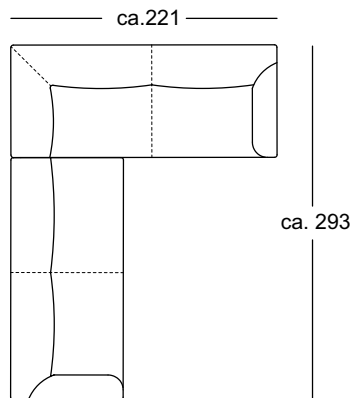

H-E-ASO 328/221 ri.  
H-ASO 328/200 le.

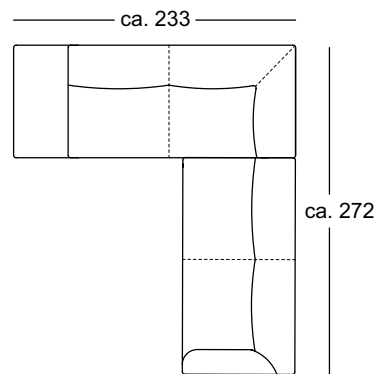

E-ARB-PSZ 328/233 le.  
ASO 328/179 ri.