

TECHNISCHE GEGEVENS

# ROLF BENZ 328



**ROLF  
BENZ**

- Houten binnenromp
- Nosag veren
- Rug van polyurethaanschuim
- Zitting van polyurethaanschuim, gelaagde opbouw, met verschillende hoogtes en uitvoeringen op elkaar afgestemd
- Bekleding onderzijde, met polyestervlies
- Slede metaal naar keuze:
  - Staal fijne structuur, gepoedercoat mat zilver
  - Staal fijne structuur, gepoedercoat mat RAL 9017 verkeerszwart
  - Staal fijne structuur, gepoedercoat mat RAL 7022 umbragrijs

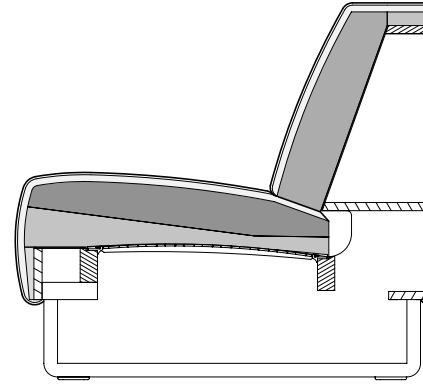

! Ploivorming en zitafdrucken zijn vanwege comfort- en designredenen ook bij hoogwaardige, gestoffeerde Rolf Benz meubels niet te vermijden. Alle maten zijn circa-maten.

Zithoogtes leverbaar

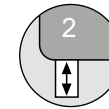

Fauteuil

Bank

Aanbouwbank\*

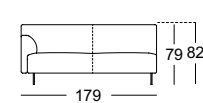
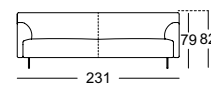
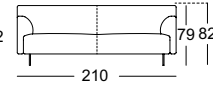
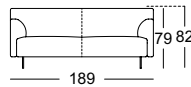
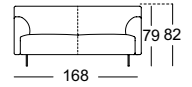
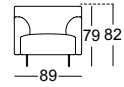
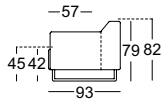

Eindelement met gestoffeerde zitting\*

Hoek-aanbouwbank\*

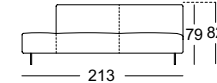
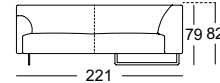
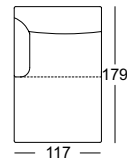
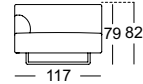
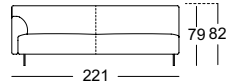
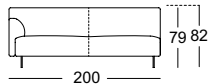

**ROLF  
BENZ**

Hoek-aanbouwbank met zitting\*



Fauteuil met hoge rugleuning

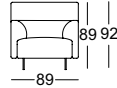

Bank met hoge rugleuning

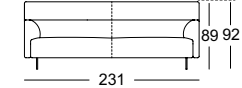
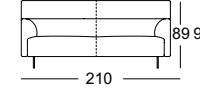
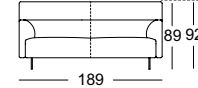
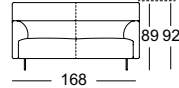

Aanbouwbank met hoge rugleuning\*

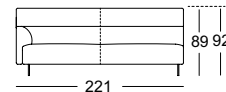
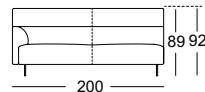
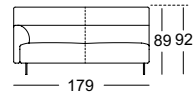
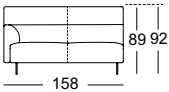

Hoge eidelement met gestoffeerde zitting\*

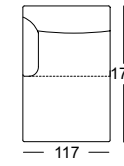
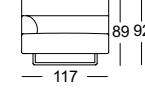

Hoek-aanbouwbank met hoge rugleuning\*

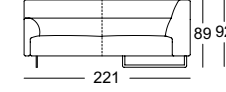

Aanbouwbank met zitting en hoge rugleuning\*

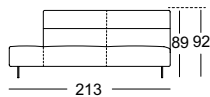

Hoek aanbouwbank met zitting en hoge rugleuning\*

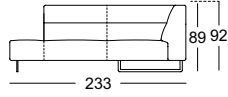

Voetenbank

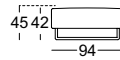
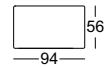

\*Deze elementen zijn als linker uitvoering afgebeeld, ze zijn echter ook in spiegelbeeld, in de rechter uitvoering leverbaar.

**ROLF  
BENZ**

Combinatie voorbeelden:

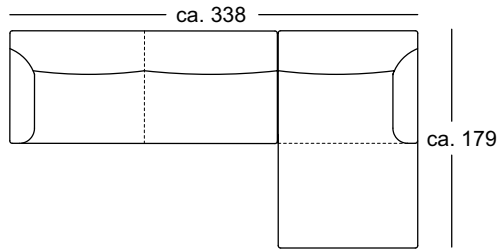

H-ASO 328/221 li.  
H-ASS-PSZ 328/117 re.

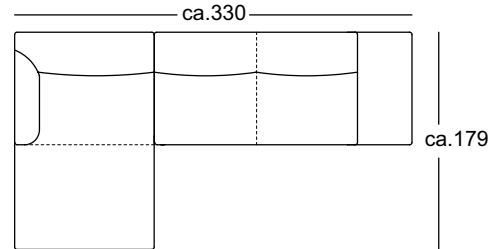

ASS-PSZ 328/117 li  
ARB\_PSZ 328/213 re.

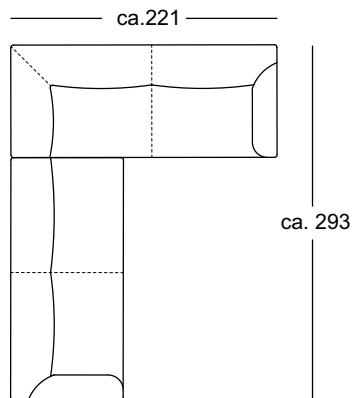

H-E-ASO 328/221 re.  
H-ASO 328/200 li.

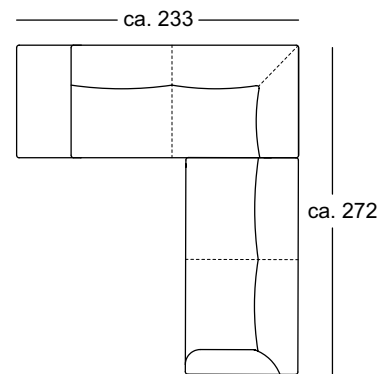

E-ARB-PSZ 328/233 li.  
ASO 328/179 re.