

TECHNICAL DATA

ROLF BENZ DONO Classic/Lounge



**ROLF
BENZ**

- Downy-soft cushions worked into ticking chambers with a filling of foam rods and polyester fibres, reinforced by a supportive core of polyether foam and a stabilizing wooden panel
- Seat in polyurethane foam, built up in coordinated layers varying in height and firmness, covered with a downy-soft mat worked into ticking chambers and filled with foam rods and polyester fibres
- Seat with wooden inner frame
- Coil spring support (upholstered bench without coil spring support)
- Coupling for modular sofa elements with suspension fitting
- Frame in matt brushed stainlesssteel
- The rail surface is available in four finish variants:
 - in oak veneer stained in accordance with the Rolf Benz colour chart,
 - against a surcharge in american walnut veneer
 - against a surcharge with leather cover
 - without storage shelf, price reduction

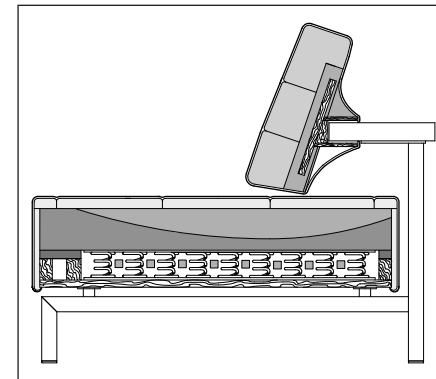

! Wave formation and depressions in the seat area are unavoidable, due to comfort and design reasons, even in high quality Rolf Benz upholstered furniture. All measurements are approximate.

Classic

Lounge

Sofa

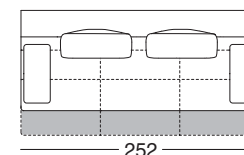
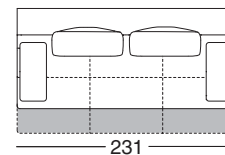
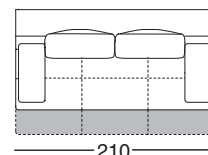
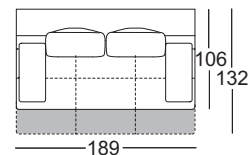
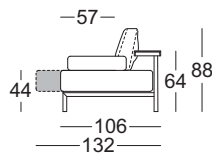
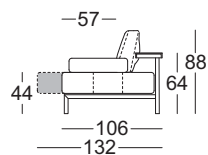

Sectional sofa element*

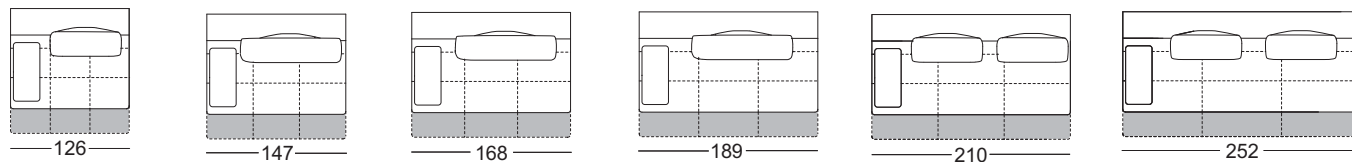

Corner sofa element*

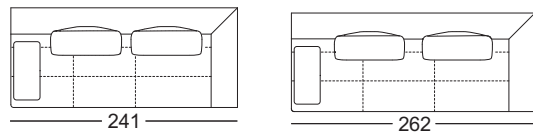

Lounge*

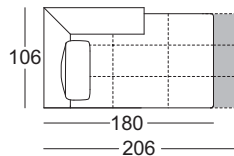

Corner unit

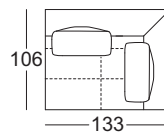

Closing chair with fixed footstool*

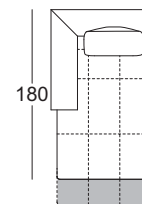

Ottoman

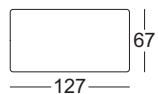

Adjustable back cushion

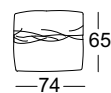
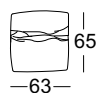
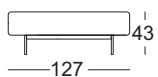

Seat adjustment



Seat cushions may be flexibly fixed to shelf



Adjustable back cushions



Loose side element cushions facilitate reclining function



*These elements are only shown in the left version. They are also available in the right version.

DONO Classic



DONO Lounge

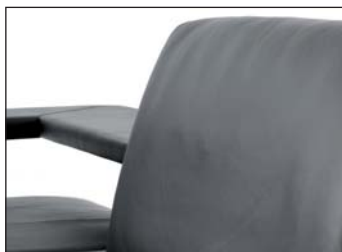

Combination examples

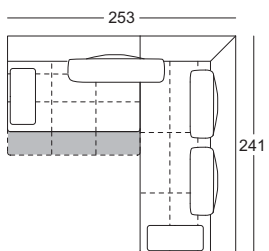

ASO 147 le.
E-ASO 241 ri.

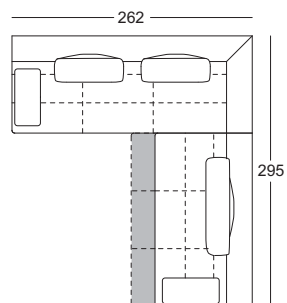

E-ASO 262 le.
ASO 189 ri.

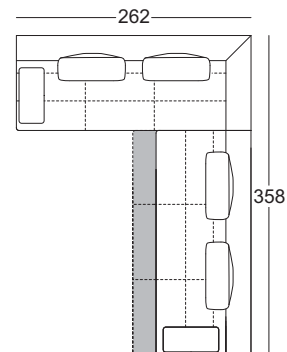

E-ASO 262 le.
ASO 252 ri.

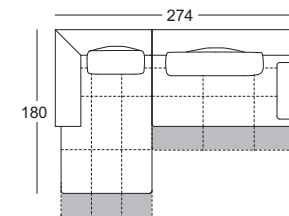

ASS-PSZ 106 le.
ASO 168 ri.