



EGO Typ G



EGO Typ F

soft

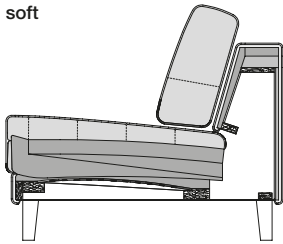

medium

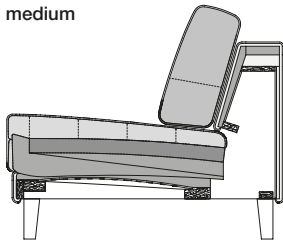

fest

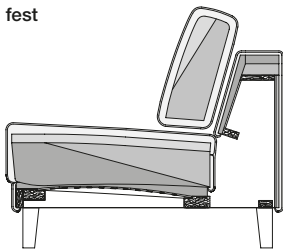

- Stabiles Holzinnengestell mit Stahlwellenunterfederung
- Sitzauflage aus hochwertigem Polyether
- Rückenauflage aus hochwertigem Polyether
- Korpusbezug mit Polyestervlies unterstept
- Sitzkissen

soft:

Kern aus einer weich abgestimmten Kombination, bestehend aus viscoelastischem Schaum und Polyetherschaum, eingearbeitet in eine mit hochelastischen Polyetherstäbchen und weichen Polyesterfasern gefüllte Matte. Eingearbeitete Stege verhindern das Wandern der Füllung.

medium:

Kern aus einer hochelastisch abgestimmten Kombination, bestehend aus viscoelastischem Schaum und Polyetherschaum, eingearbeitet in eine mit hochelastischen Polyetherstäbchen und weichen Polyesterfasern gefüllte Matte. Eingearbeitete Stege verhindern das Wandern der Füllung.

fest:

hochwertiger Polyether, schichtweise aufgebaut und in verschie-

denen Höhen und Härten aufeinander abgestimmt, abgedeckt mit einer hochwertigen Vlies-/Schaum-Verbundmatte.

- Lose Rückenkissen:

soft:

Füllung aus hochelastischen Polyetherstäbchen und weichen Polyesterfasern, eingearbeitete Kammerstege verhindern das Wandern der Füllung.

medium:

Füllung aus hochelastischen Polyetherstäbchen und weichen Polyesterfasern, eingearbeitete Kammerstege verhindern das Wandern der Füllung.

fest:

hochwertiger Polyether, schichtweise aufgebaut und in verschiedenen Höhen und Härten aufeinander abgestimmt, abgedeckt mit einer hochwertigen Vlies-/Schaum-Verbundmatte.

- Koppelung der Anreihenelemente mit Einhängebeschlag
 - Füße aus Metall oder Holz in verschiedenen Ausführungen
- ! Wellenbildung und Sitzspiegel sind aus Komfort- und Designgründen auch bei hochwertigen Rolf Benz Polstermöbeln nicht zu vermeiden. Alle Maße sind ca.-Angaben.



**Clubessel
EGO Typ G**



**Clubessel
EGO Typ F**

- Holz-Innengestell
- Polstergurt-Unterfederung
- Rückenauflage aus Polyetherschaum
- Lose Rückenlehnen: Rückenlehnen aus Polyetherschaum, abgedeckt mit Polyester-Vlies
- Sitz:
 - medium: Sitz mit mittlerer Festigkeit und komfortabler Unterstützung durch einen progressiven Aufbau unterschiedlich fester hochelastischer Schichten aus Polyetherschaum. Eine anschmiegsame Oberfläche entsteht bei diesem Sitz durch Abdeckung einer hochwertigen Vlies-/Schaum-Verbundmatte. Der progressive Aufbau ermöglicht ein angenehm unterstütztes aber dennoch weiches Einsitzen.

fest: Der Sitz ist aus mehreren Schichten unterschiedlich fester Polyetherschäume mit unterschiedlichen Stauchhärten aufgebaut. Der progressive Aufbau bedingt ein nur leichtes Einsitzen und eine intensive Sitzunterstützung.

- Korpus-Bezug mit Polyester-Vlies unterstept
 - Wahlweise 12 mm hoher Kunststoff-Gleiter oder Rollen. Durch die Rollen erhöhen sich alle Höhen um 3 cm
- ! Wellenbildung und Sitzspiegel sind aus Komfort- und Designgründen auch bei hochwertigen Rolf Benz Polstermöbeln nicht zu vermeiden. Alle Maße sind ca.-Angaben.

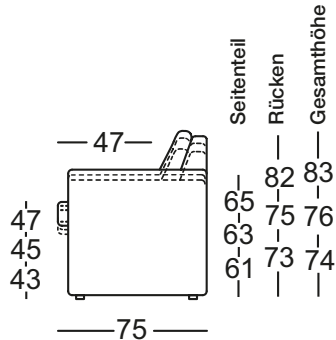
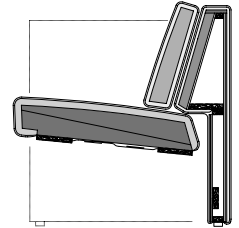

Sitzbreite 54 cm

Sitzbreite 58 cm

CL-SE EGO



Seitenteil schmal

Seitenteil breit

Seitenteil XL

Seitenteil verstellbar

SE EGO



-

-

SOB EGO/SB 126

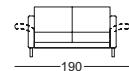
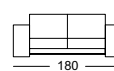

SOB EGO/SB 147

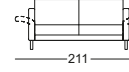
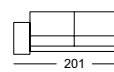

SOB EGO/SB 168

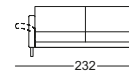
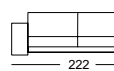

SOB EGO/SB 189

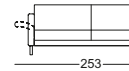
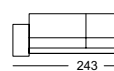

SOB EGO/SB 210

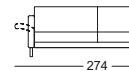
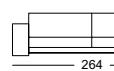

ASS EGO/SB 63*



ASS EGO/SB 74*



ASS EGO/SB 84*



ASS EGO/SB 95*



ASO EGO/SB 105*



ASO EGO/SB 126*



ASO EGO/SB 147*



ASO EGO/SB 168*



ASO EGO/SB 189*



ASO EGO/SB 210*



W-ASO EGO/SB 174*



-



Seitenteil schmal

Seitenteil breit

Seitenteil XL

Seitenteil verstellbar

ASS-PSZ EGO/SB 74*



—



ASS-PSZ EGO/SB 105*



—



ARB-PSZ EGO/SB 147*



ARB EGO/SB 105



EPT EGO 62/62



ARB-PSZ EGO/SB 168*

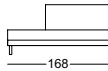

ARB EGO/SB 126



EPT EGO 55/62



ASE EGO/SB 63



ARB EGO/SB 147



EPT EGO 62/55



ASE EGO/SB 74



ARB EGO/SB 168

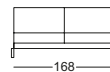

REPT EGO



ASE EGO/SB 84



EPT EGO 52/52



PSZ EGO

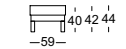

ASE EGO/SB 95



EPT EGO 55/55



PB EGO

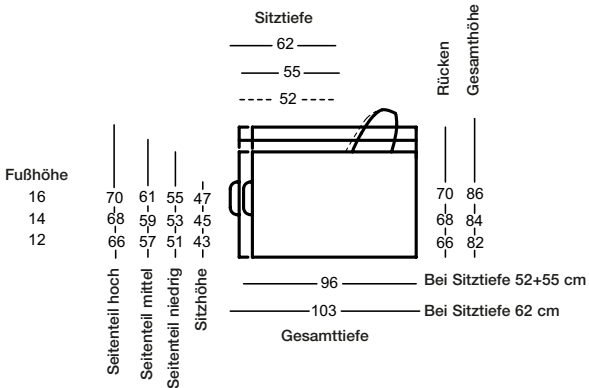
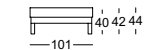

ASS-PSZ

Sitztiefe/für Anreihersitztiefe

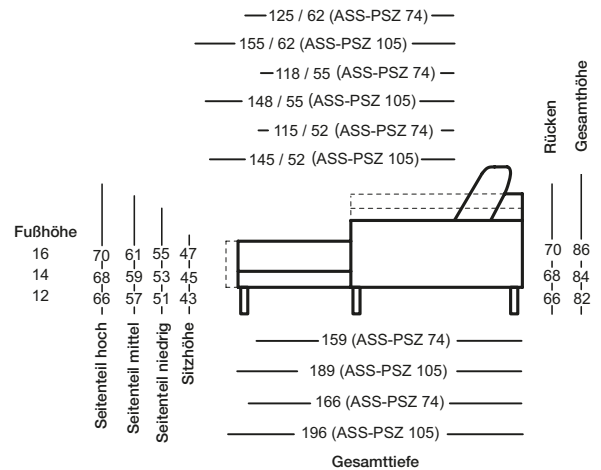

*Diese Elemente sind in ihrer linken Ausführung abgebildet. Sie sind aber auch gespiegelt in der rechten Ausführung verfügbar.

Alle technischen Angaben zu den Möbelprogrammen basieren auf dem Zeitraum vor dem Druck, spätere Änderungen sind möglich. Alle Abmessungen sind Zirka-Maße. Die abgebildeten Polsterbezüge und Oberflächen sind unverbindliche Beispiele und können vom Original abweichen. Maßgebend für Ihre Auswahl sind immer die jeweils gültigen Rolf Benz Bezugskollektionen bei Ihrem Fachhändler.