

Technical part



EGO Typ G



EGO Typ F

Medium

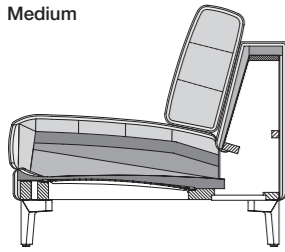

Firm

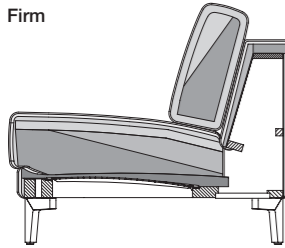

Lounge plus

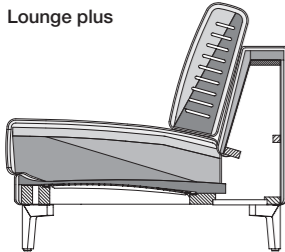

- Wooden inner frame
- No-sag spring support (upholstered seat and upholstered bench without spring support). Exceptions are the EPT and PB models and the PSZ, where high-quality polyurethane foams are used for constructive reasons
- Seat pad in polyurethane foam
- Back pad in polyurethane foam
- Body cover quilted underneath with non-woven polyester
- **Seat comfort medium:**
 - › Seat made of polyurethane foam, built up in layers to achieve a balance of different heights and firmnesses. Covered with a mat to achieve a down-like effect, which has chambers worked into it and is filled with foam rods and polyester fibres
 - › Seat cover quilted underneath with non-woven polyester
 - › Backrest cushions: Loose backrest cushions that are down-like in nature, comprising chambers with a filling made of foam rods and polyester fibre balls.
- **Seat comfort firm:**
 - › Seat made of high-quality cold foam, built up in layers and coordinated in different thick-

- nesses and hardnesses with a polyester fleece covering.
 - › Seat cover quilted underneath with non-woven polyester
 - › Backrest cushions: Backrest cushions made of polyurethane foam covered with a fleece/foam composite pad.
- **Seat comfort lounge plus:**
 - › Seat made of high-quality cold foam, built up in layers and coordinated in different thicknesses and hardnesses with a polyester fleece covering.
 - › Seat cover quilted underneath with non-woven polyester
 - › Backrest cushions: Backrest cushions made of polyurethane foam covered with a fleece/foam composite pad.
- Coupling for modular sofa elements with suspension fitting
- Legs in metal or wood in different finishes

! Due to the way the furniture is designed, and its comfort level, some wrinkles and sitting pressure indentations are inevitable, even in top quality Rolf Benz upholstered furniture. All dimensions are approximate.

Technical part armchair



EGO Typ G



EGO Typ F

- Wooden inner frame
- Elastic webbing
- Back pad in polyether foam
- Loose back cushion: Back cushion in polyether foam, covered with polyester fleece
- Seat comfort:
 - Medium:** Moderately firm seat with comfortable support, due to a progressive structure of highly elastic polyether foam layers of differing degrees of firmness. A snug surface is created by covering the cushion with a mat made from a combination of high-quality fleece and foam. The progressive structure ensures a pleasantly soft “sitting-in” sensation while affording adequate support.
 - Firm:** Seat with relatively high level of firmness and comfortable support due to a pro-

- gressive structure of different but consistently firm layers of polyether foam. A hugging seat surface is created by covering with a high-grade non-woven/foam composite mat. The progressive structure results in only a slight “sitting-in” sensation and intensive seat support.
- Body cover quilted underneath with non-woven polyester
- Optionally 12 mm high plastic glides or casters. With casters, all heights are increased by 3 cm

! Due to the way the furniture is designed, and its comfort level, some wrinkles and sitting pressure indentations are inevitable, even in top quality Rolf Benz upholstered furniture. All dimensions are approximate.

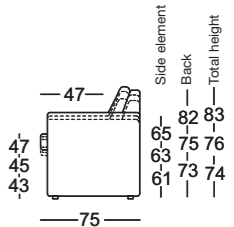
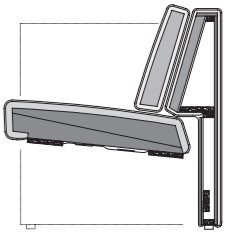

Technical part functional recliner

571



Medium

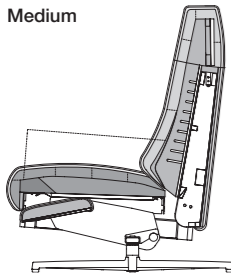

Firm

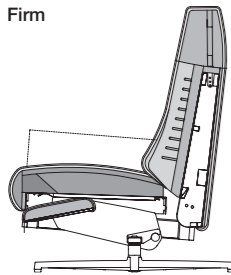

Lounge plus

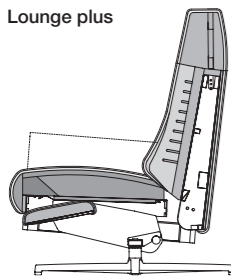

- Metal inner frame with integrated rotary and adjustment function
- Version with electrical adjustment function: Stepless electric motor-powered adjustment
- Seat and backrest can be individually steplessly adjusted to the relax position
- Nosag spring support
- **Seat comfort medium:**
 - › Seat made of polyurethane foam, built up in layers to achieve a balance of different heights and firmnesses. Covered with a mat to achieve a down-like effect, which has chambers worked into it and is filled with foam rods and polyester fibres.
 - › Back surface made from polyurethane foam, covered in polyester fleece
 - › Steplessly adjustable headrest, tilt action
 - › Cover
- **Seat comfort firm:**
 - › Seat made from polyurethane foam, constructed in layers of different thicknesses and firmnesses, matched to one another, and covered with polyester fleece
 - › Back surface made from polyurethane foam, covered in polyester fleece
 - › Steplessly adjustable headrest, tilt action
 - › Cover
- **Seat comfort lounge plus:**
 - › Seat built up in layers with polyurethane foam and a high-quality cold foam, coordinated in different heights and hardnesses, with a polyester fleece covering
 - › Back surface made from polyurethane foam, covered in polyester fleece
 - › Steplessly adjustable headrest, tilt action
 - › Cover
- **Leg finish:**
 - › Cross foot aluminium, fine structure, powder-coated, silk matt RAL 9017 traffic black
 - › Cross foot polished aluminium
 - › Star base steel, fine structure, powder-coated, silk matt RAL 9017 traffic black
 - › Star base steel, fine structure, powder-coated, silk matt RAL 7022 umbra grey
 - › Steel star base, polished chrome

! Due to the way the furniture is designed, and its comfort level, some wrinkles and sitting pressure indentations are inevitable, even in top quality Rolf Benz upholstered furniture. All dimensions are approximate.

CL-SE EGO/LSE 571

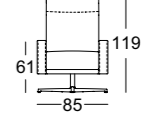
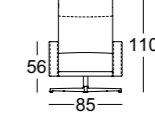
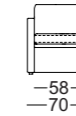
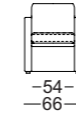

Side element narrow

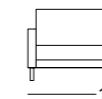
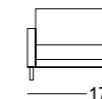
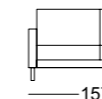
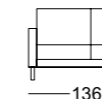
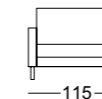
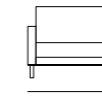
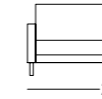
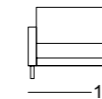
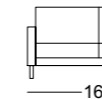
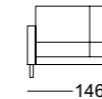
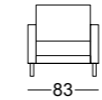

Side element wide

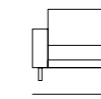
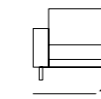
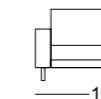
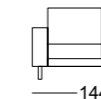
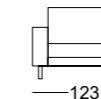
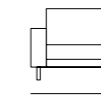
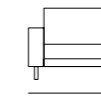
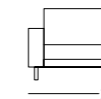
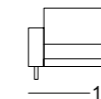
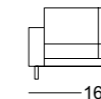
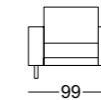

Side section with cushion

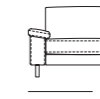
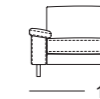
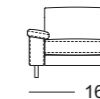
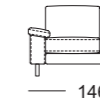
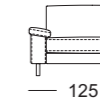
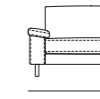
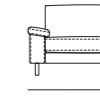
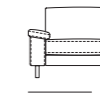
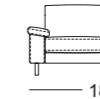
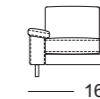
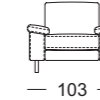

Adjustable side element

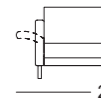
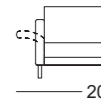
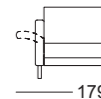
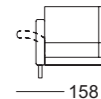
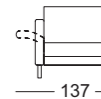
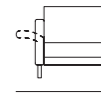
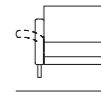
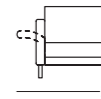
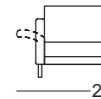
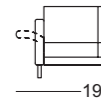
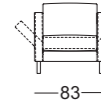

SE EGO

SOB EGO/SB 126

SOB EGO/SB 147

SOB EGO/SB 168

SOB EGO/SB 189

SOB EGO/SB 210

ASO EGO/SB 105

ASO EGO/SB 126

ASO EGO/SB 147

ASO EGO/SB 168

ASO EGO/SB 189

Side element narrow Side element wide Side section with cushion Adjustable side element

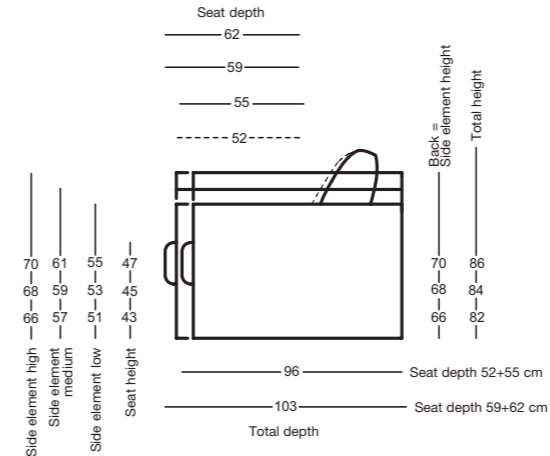
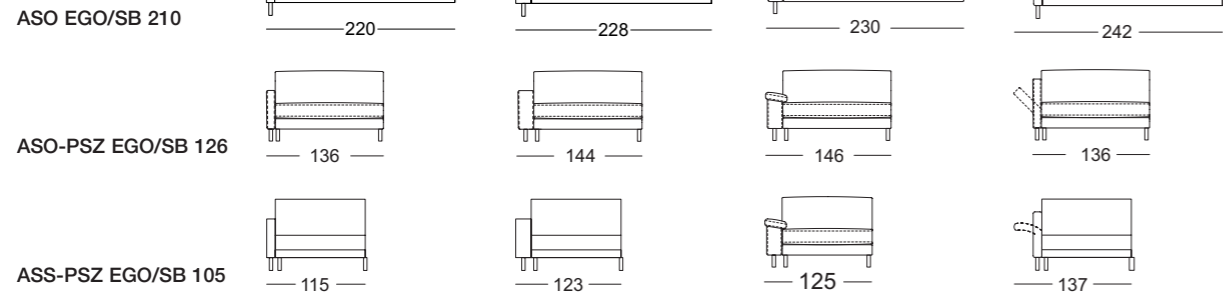

ASS-PSZ:

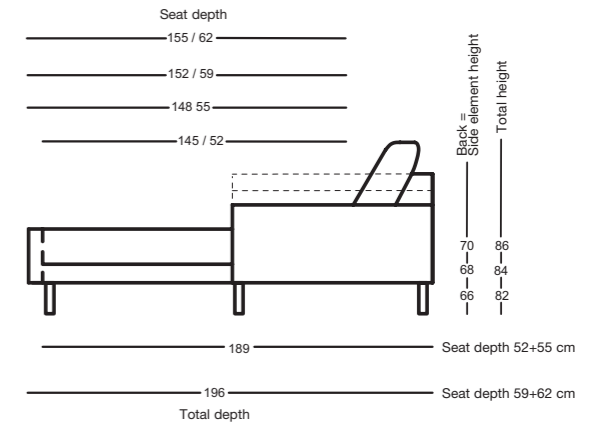

The specified seat height dimensions are measured at the front edge of the seat upholstery. The measurements are approximate. Upholstery dimensions may vary depending on the different elasticities of the cover fabrics, different upholstery structures and usage behaviour.

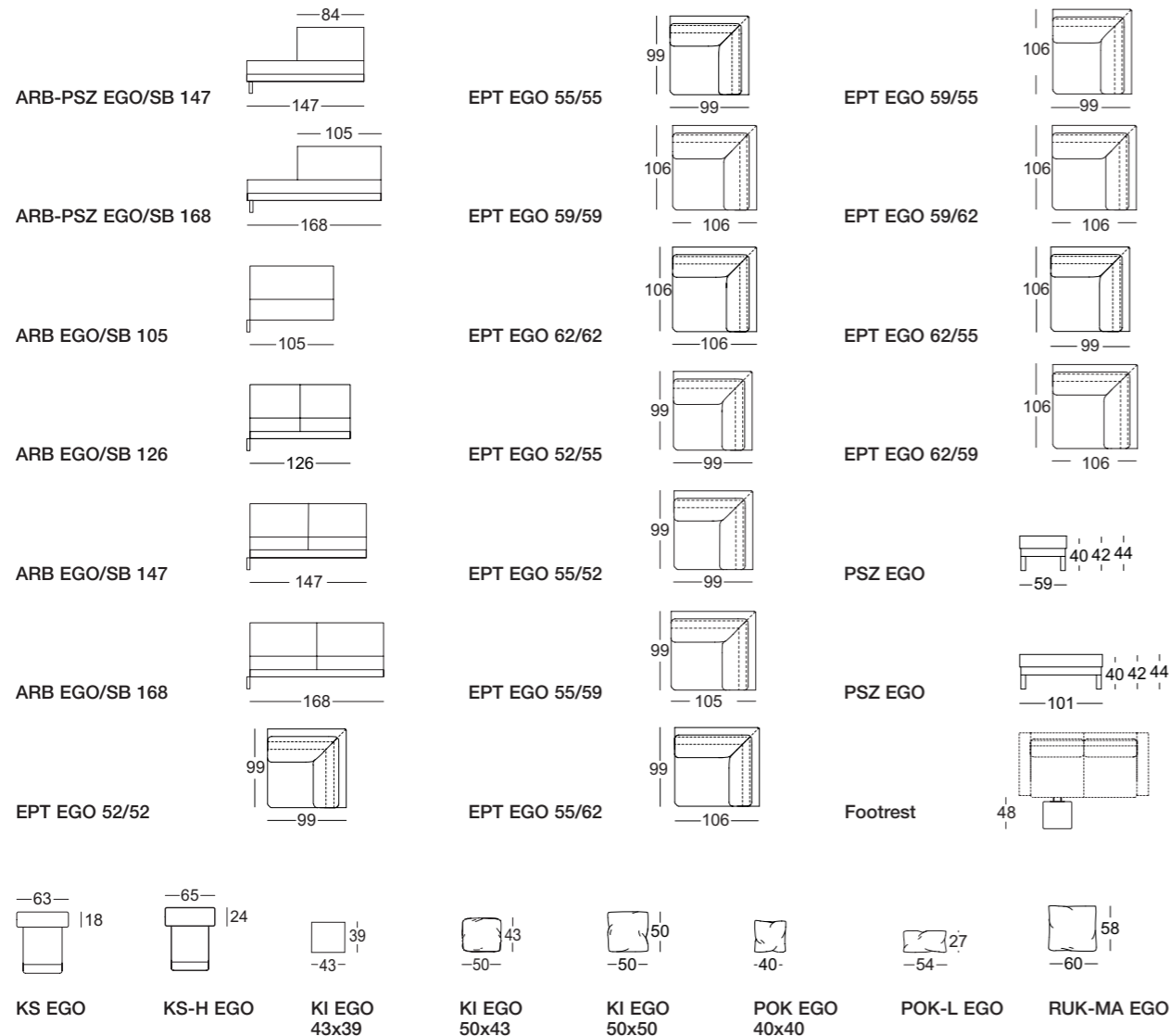

Combination examples

