

## Partie technique



EGO Typ G



EGO Typ F

Medium

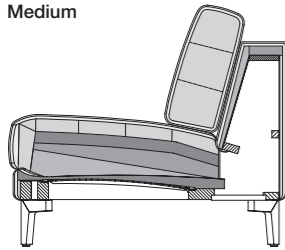

Ferme

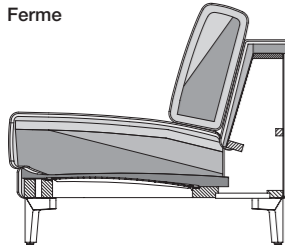

Lounge plus

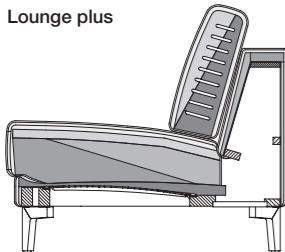

- Structure intérieure en bois
- Suspension à ressorts ondulés de type Nosag (assise et pouf-banquette sans suspension). Les modèles EPT et PB constituent des exceptions : pour des raisons liées à leur construction, ils nécessitent en effet la mise en œuvre de mousses de polyuréthane de grande qualité.

Même chose pour le modèle PSZ.

- Enrobage d'assise en mousse de polyuréthane
- Enrobage de dossier en mousse de polyuréthane
- Revêtement du bâti doublé de non-tissé polyester
- **Confort « medium » :**
  - › Assise en mousse de polyuréthane, couches superposées de hauteurs et densités différentes, recouverte d'une nappe de type couette, piquage carreaux cloisonnés, et garnie d'un mélange composé de bâtonnets de mousse et de fibres de polyester.
  - › Revêtement de l'assise doublé de non-tissé polyester
  - › Coussin de dossier : Coussins de dossier mobiles, garnissage de type couette, piquage carreaux cloisonnés, constitué de bâtonnets de mousse et de fibres de polyester.
- **Confort « ferme » :**
  - › Assise en mousse de polyuréthane, couches superposées de hauteurs et densités diffé-

rentes, recouverte d'une nappe composite en non-tissé et mousse.

- › Revêtement de l'assise doublé de non-tissé polyester
- › Coussin de dossier : Coussin de dossier en mousse de polyuréthane recouverte d'une nappe composite en non-tissé et mousse.

• **Confort « lounge plus » :**

- › Assise en mousse à froid de grande qualité, garnissage multicouches de hauteurs et densités différentes, enrobage dans une housse de non-tissé polyester.
- › Revêtement de l'assise doublé de non-tissé polyester
- › Coussin de dossier : Coussin de dossier en mousse de polyuréthane recouverte d'une nappe composite en non-tissé et mousse
- Assemblage des éléments composables par garniture suspendue
- Piétement en métal ou en bois, proposé en plusieurs finitions

! Pour des raisons de confort, mais aussi de design, la formation d'ondulations et de d'empreintes d'assise est inévitable, même sur les sièges de très haut de gamme édités par Rolf Benz. Toutes les dimensions indiquées sont susceptibles de varier légèrement.

## Partie technique fauteuil club



EGO Typ G



EGO Typ F

- Structure intérieure en bois
- Suspension à lattes souples
- Enrobage de dossier en mousse de polyéther
- Coussins de dossier mobiles : Coussin de dossier en mousse de polyéther, recouverte de non-tissé polyester
- Coussins d'assise **Confort « medium » :** Assise de fermeté moyenne. La superposition de couches de mousse de polyéther de hauteurs et densités différentes assure un confort progressif. Le coussin doit le moelleux de sa surface à un enrobage composite constitué de non-tissé et de mousse. Le confort progressif est obtenu grâce à une technique de garnissage qui garantit à la fois un soutien agréable et une assise moelleuse.

**Confort « ferme » :** Assise assez ferme, assurant un soutien confortable et progressif grâce à

la mise en œuvre de couches de mousse de polyéther présentant divers degrés de fermeté. La surface moelleuse résulte de la mise en œuvre d'une nappe composite en non-tissé et mousse. La technique de garnissage utilisée fait que le corps ne s'enfonce pas dans le siège tout en étant bien soutenu.

- Revêtement du bâti doublé de non-tissé polyester
  - Au choix, patins en matière synthétique, hauteur 12 mm, ou roulettes. Les roulettes augmentent toutes les hauteurs de 3 cm
- ! Pour des raisons de confort, mais aussi de design, la formation d'ondulations et de d'empreintes d'assise est inévitable, même sur les sièges de très haut de gamme édités par Rolf Benz. Toutes les dimensions indiquées sont susceptibles de varier légèrement.

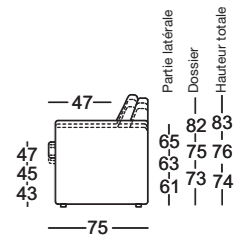
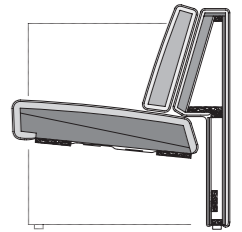

CL-SE EGO/  
SB 54/SB 58



Accouoir étroit

Accouoir large

Accouoir avec  
coussin

Accouoir réglable

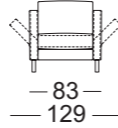
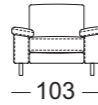
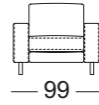
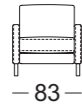

SE EGO

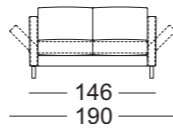
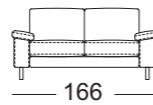
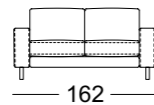
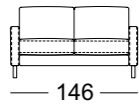

SOB EGO/SB 126

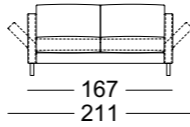
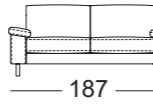
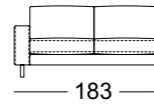
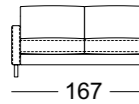

SOB EGO/SB 147

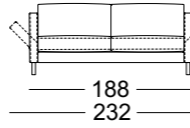
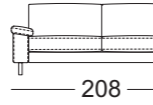
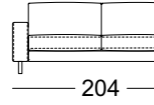
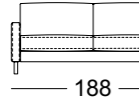

SOB EGO/SB 168

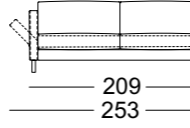
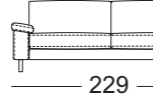
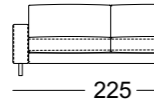
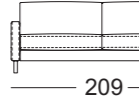

SOB EGO/SB 189

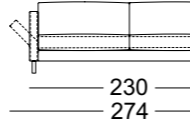
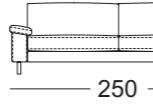
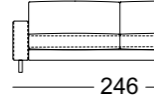
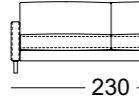

SOB EGO/SB 210

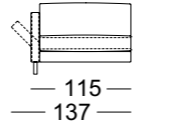
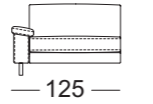
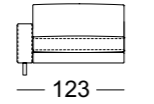
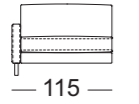

ASO EGO/SB 105

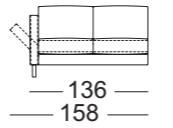
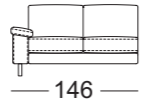
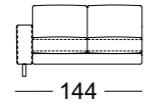
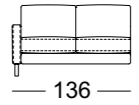

ASO EGO/SB 126

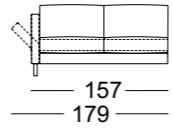
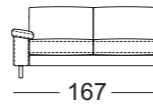
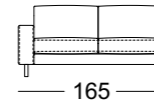
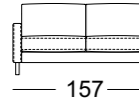

ASO EGO/SB 147

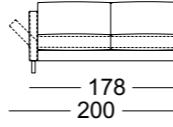
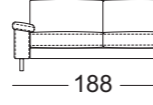
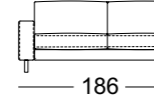
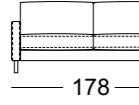

ASO EGO/SB 168

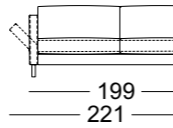
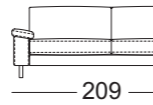
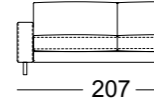
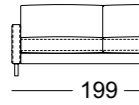

ASO EGO/SB 189

Accouoir étroit

Accouoir large

Accouoir avec  
coussin

Accouoir réglable

ASO EGO/SB 210

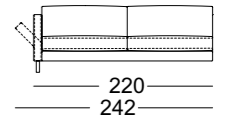
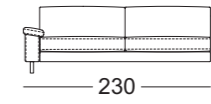
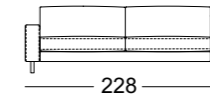
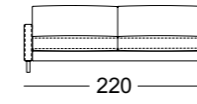

ASO-PSZ EGO/SB 126

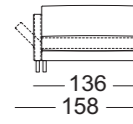
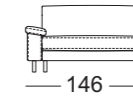
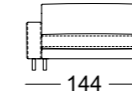
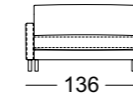

ASS-PSZ EGO/SB 105

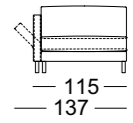
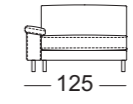
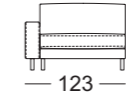
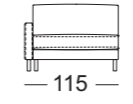

ARB-PSZ EGO/SB 147

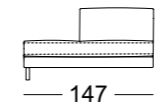

EPT EGO 55/55

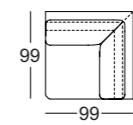

EPT EGO 59/55

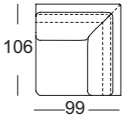

ARB-PSZ EGO/SB 168

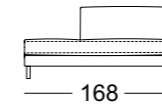

EPT EGO 59/59

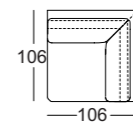

EPT EGO 59/62

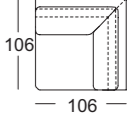

ARB EGO/SB 105

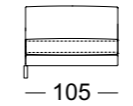

EPT EGO 62/62

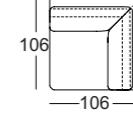

EPT EGO 62/55

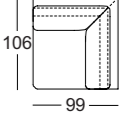

ARB EGO/SB 126

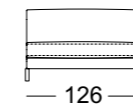

EPT EGO 52/55

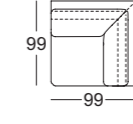

EPT EGO 62/59

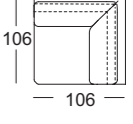

ARB EGO/SB 147

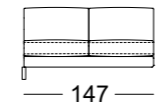

EPT EGO 55/52

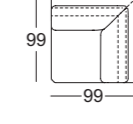

PSZ EGO

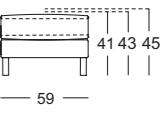

ARB EGO/SB 168

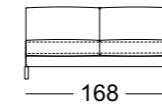

EPT EGO 55/59

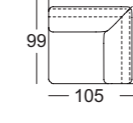

PB EGO

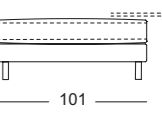

EPT EGO 52/52

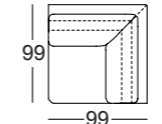

EPT EGO 55/62

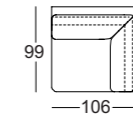

Repose-pied

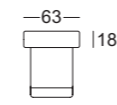
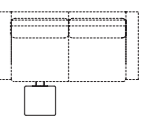

KS EGO

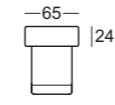

KS-H EGO



KI EGO  
43x39



KI EGO  
50x43



KI EGO  
50x50



POK EGO  
40x40



POK-L EGO



RUK-MA EGO

## ASS-PSZ:

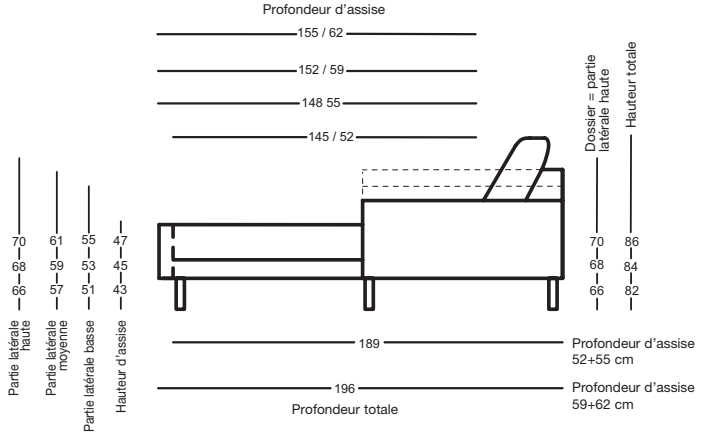
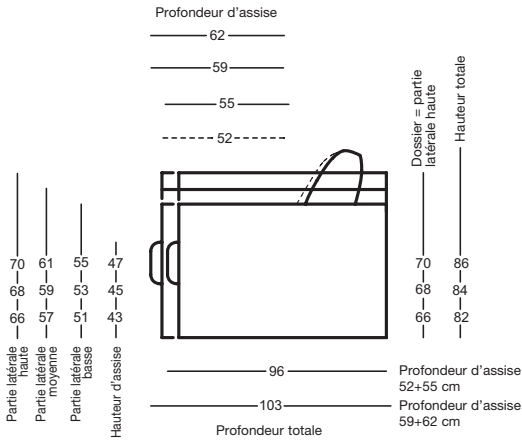

Les hauteurs d'assise indiquées sont mesurées à partir du bord avant du coussin d'assise. Les dimensions sont approximatives. Les dimensions du garnissage peuvent varier en raison de l'extensibilité plus ou moins importante des matières de recouvrement, des différences de garnissage et de l'utilisation qui est faite du siège.

## Exemples d'associations

