

TECHNISCHE GEGEVENS

ROLF BENZ 318 LINEA



**ROLF
BENZ**

- Houten binnenromp
- Nosag veren
- Bekleding onderzijde, met polyestervlies
- Rug van polyurethaanschuim
- Classic:
 - Zitting van polyurethaanschuim, gelaagde opbouw, met verschillende hoogtes en uitvoeringen op elkaar afgestemd
- Lounge plus:
 - Zitting van hoogwaardig koudschuim
- Poten naar keuze:
 - Spang roestvrij staal
 - Spang gelakt in verkeerszwart RAL 9017
- Kegelpoot naar keuze
 - Poot eiken H70
 - Poot eiken H98
 - Poot notenhout H81

! Ploovorming en zitspiegel zijn vanwege comfort- en designredenen
 ook bij hoogwaardige, gestoffeerde Rolf Benz-meubels niet te vermijden. Alle maten zijn circa-maten.

Classic

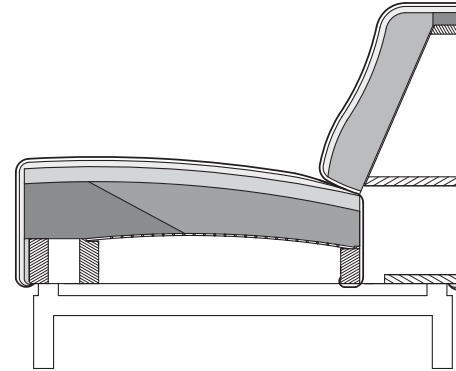

Lounge plus

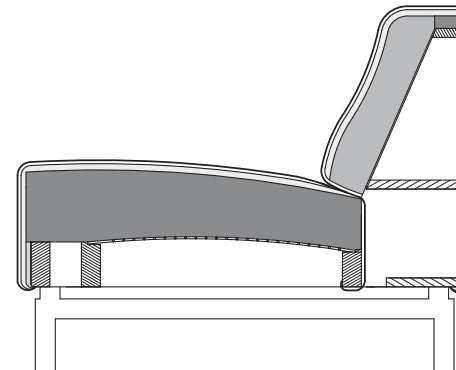

Zithoogtes leverbaar



**ROLF
BENZ**

Fauteuil

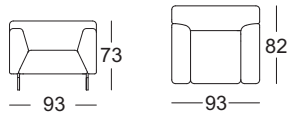

Bank

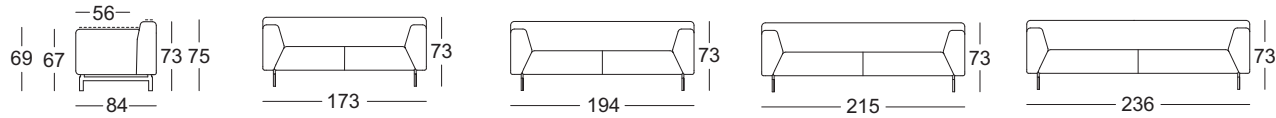

Aanbouwbank*

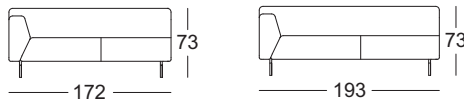

Eindelement met gestofferde zitting*

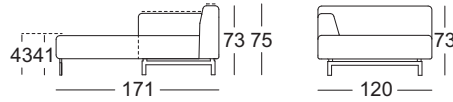

Hoek-Aanbouwbank

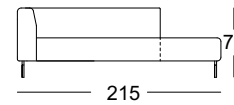

Fauteuil met extra diepte

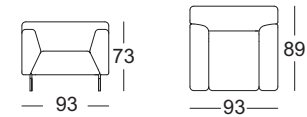

Sofa met extra diepte

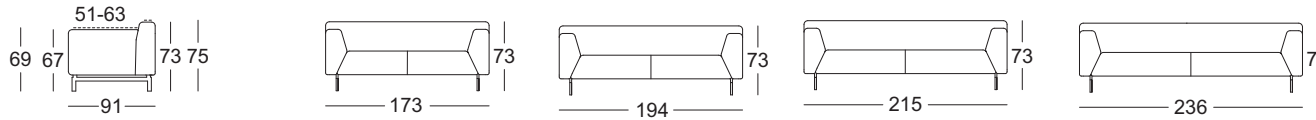

Aanbouwbank met extra diepte*

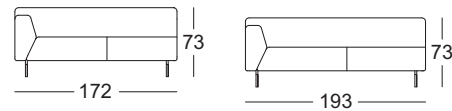

Eindelement met extra diepte en gestofferde zitting *

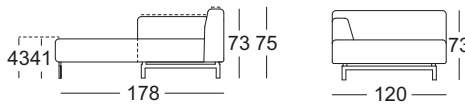

Hoek-Aanbouwbank met gestofferde zitting*

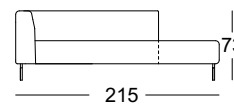

Voetenbank groot

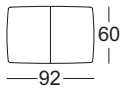

Gestoffeerde zitting



Lage rugkussen



Rugkussen

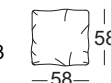

**ROLF
BENZ**

Combinatie voorbeelden

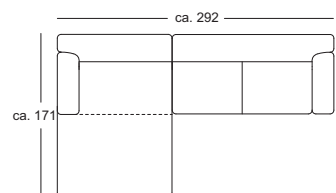

ASS-PSZ 318/120 li.
ASO 318/172 re.

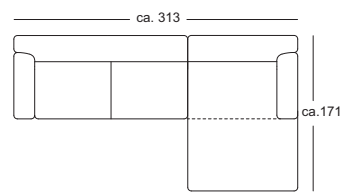

Ü-ASO 318/193 li.
Ü-ASS-PSZ 318/120 re.

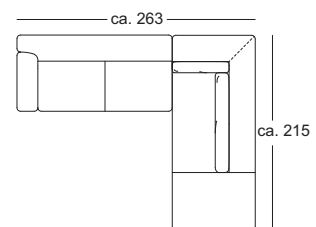

ASO 318/172 li.
Ü-E-ARB-PSZ 318/215 re.

*Deze elementen zijn als linker uitvoering afgebeeld, ze zijn echter ook in spiegelbeeld, in de rechter uitvoering leverbaar.

**ROLF
BENZ**