

TECHNICAL DATA

# ROLF BENZ 386 MERA

---



**ROLF  
BENZ**

- Seat with metal inner frame and integrated rotary function
- Nosag spring support
- Seat made from polyurethane foam, constructed in layers of different thicknesses and firmnesses, matched to one another, and covered with polyester fleece
- Backrest with metal inner frame and integrated adjustment function
- Back in polyurethane foam, built up in coordinated layers, varying in height, and firmness
- Cover quilted underneath with non-woven polyester
  - Base frame in metal, optionally with surface in
  - Frame metal optionally:
    - Fine-grain steel, powdercoated, matt :
    - RAL 7044 Silk grey
    - RAL 9017 Traffic black
    - RAL 7022 Umbra grey
    - Marrone metallic
  - Steel high-gloss chrome
- Seat height options 41 cm or 44 cm

- Leg version with roller (only available with the L-SOB-BS and LC models)

Metal frame, optionally:

- Fine-grain steel, powder-coated, matt:
  - RAL 7044 Silk grey
  - RAL 9017 Traffic black
  - RAL 7022 Umbra grey
  - Marrone metallic
- High-gloss chrome steel

The roller is always black.

! High-quality, casual upholstery that forms waves/leaves indentations that are typical of the material. All measurements are approximate.

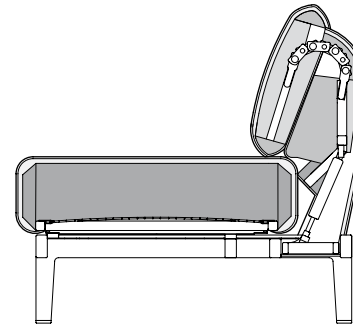

Seat heights available

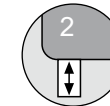

**ROLF  
BENZ**

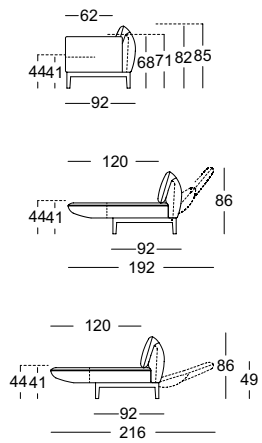

Sofa

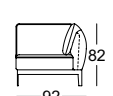
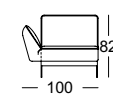
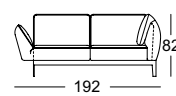
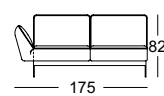
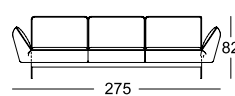
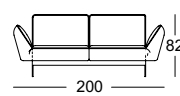
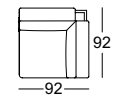
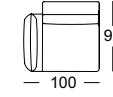
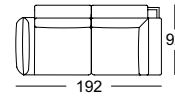
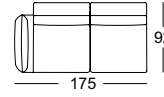
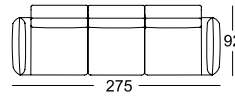
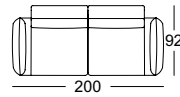

Sectional sofa\*

Corner modular sofa element\*

Sectional chair

Closing chair with armrest\*

Corner unit

Closing chair with fixed footstool\*

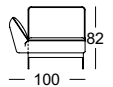
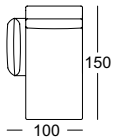

Longchair\*

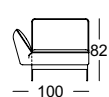
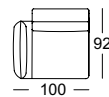

Upholstered bench



Flanged back cushion



Flanged back cushion mat



Low flanged back cushion



Low flanged upholstered cushion



Combination examples:

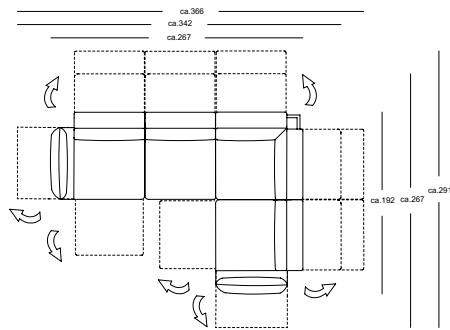

L-ASO-ES 386/175 le.  
L--E-ASO-ES 386/192 ri.

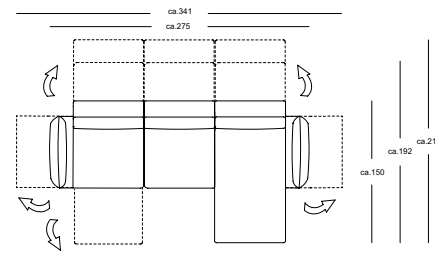

L-ASO-ES 386/175 le.  
ASS-PSZ 386//100 ri.

\*These elements are only shown in the left version. They are also available in the right version.

**ROLF  
BENZ**