

TECHNISCHE DATEN

ROLF BENZ MIOKO



**ROLF
BENZ**

SOB

- Gussfuß Metall, wahlweise: Aluminium Feinstruktur pulverbeschichtet matt:
 - RAL 9017 Verkehrsschwarz
 - RAL 7022 Umbragrau
 - Marone metallic
 - RAL 5004 Schwarzblau
 - RAL 7003 Moosgrau
 - RAL 8002 Signalbraun
 - RAL 7044 Seidengrau
 - Poliert
- Spange Stahl, wahlweise: Stahl Feinstruktur pulverbeschichtet matt:
 - RAL 9017 Verkehrsschwarz
 - RAL 7022 Umbragrau
 - Marone metallic
 - RAL 5004 Schwarzblau
 - RAL 7003 Moosgrau
 - RAL 8002 Signalbraun
 - RAL 7044 Seidengrau
 - Verchromt glänzend
- Sitzhöhen wahlweise 43 oder 46 cm

- Holz-Innengestell
- Stahlwellen-Unterfederung
- Sitz aus hochwertigem Kaltschaum, abgedeckt mit einer Matte in Daunencharakter, die in Kammern gearbeitet und mit 90 % Schaumstoffstäbchen und 10 % Polyesterfasern gefüllt ist (Lounge)
- Sitz schichtweise aufgebaut mit Polyurethanschaum und einem hochwertigen Kaltschaum, in mehreren Höhen und Härten aufeinander abgestimmt, abgedeckt mit einer Polyester-Vlieshülle (Classic)
- Rückenauflage aus Polyurethanschaum
- Rückenbezug mit Polyestervlies unterstept
- Rückenkissen in Daunencharakter, in Kammern gearbeitet mit einer Füllung aus 80 % Schaumstoffstäbchen und 20 % Polyesterfasern

! MIOKO Classic:

Hochwertiger, legerer Polsteraufbau mit warentypischer Bildung von Wellen/Sitzabdrücken. Alle Maße sind Zirka-Angaben.

MIOKO Lounge:

Hochwertiger, besonders legerer Polsteraufbau mit warentypischer Bildung von Wellen/Sitzabdrücken - stärkeres Wellenbild gegebenenfalls bereits im Neuzustand. Alle Maße sind Zirka-Angaben.

Gussfuß



Spange



Lounge

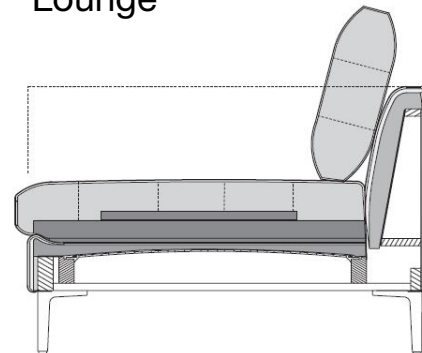

Classic

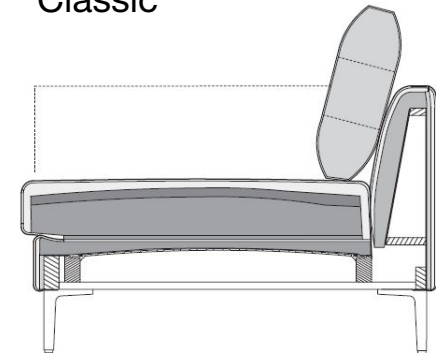

**ROLF
BENZ**

Rückenkissen mit Abstand

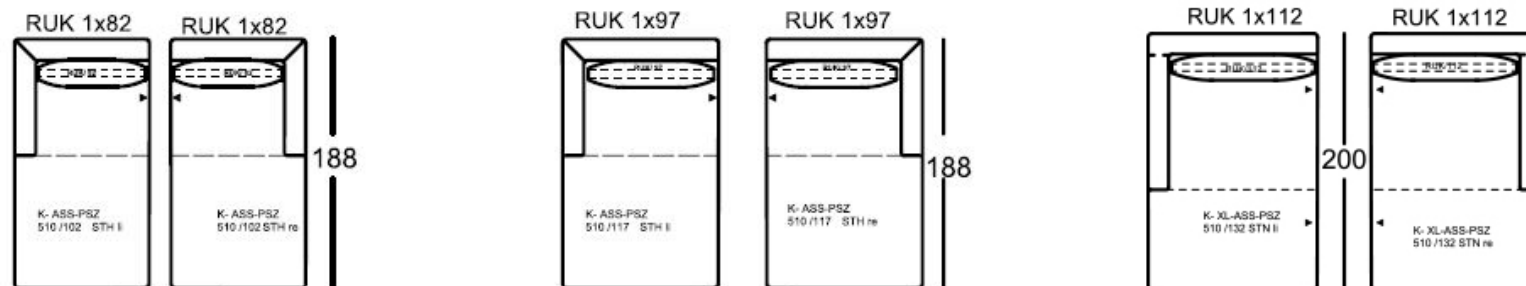
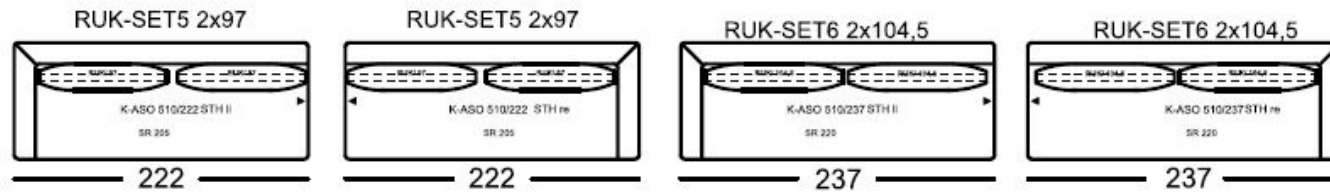
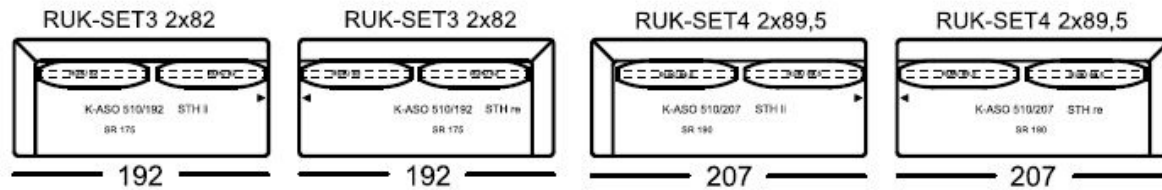
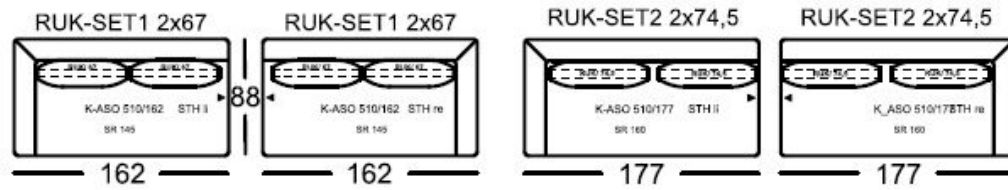
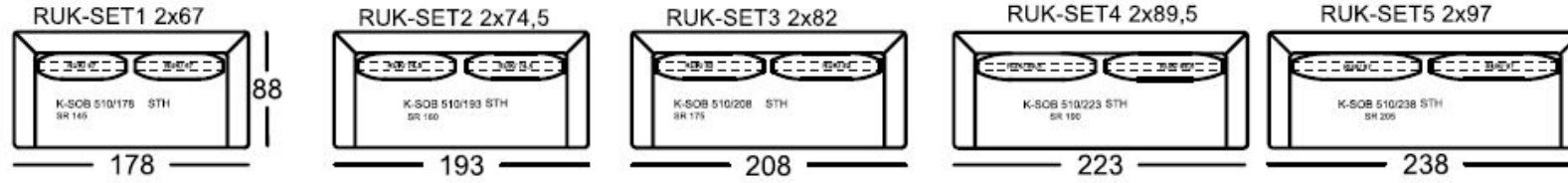

RUK-SET8 2x67 1x59,5

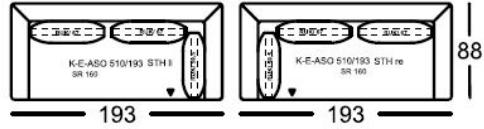

RUK-SET10 2x74,5 1x59,5

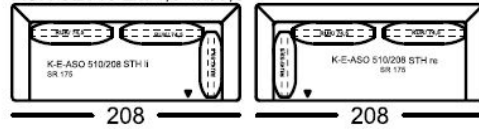

RUK-SET12 2x82 1x59,5



RUK-SET14 2x89,5 1x59,5

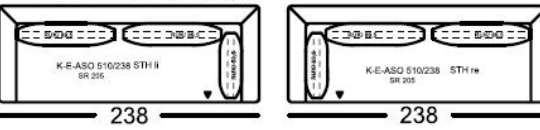

RUK-SET16 3x59,5

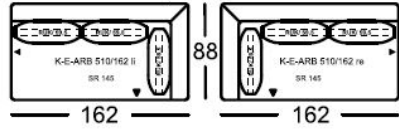

RUK-SET8 2x67 1x59,5

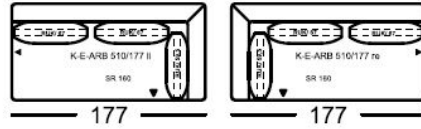

RUK-SET10 2x74,5 1x59,5

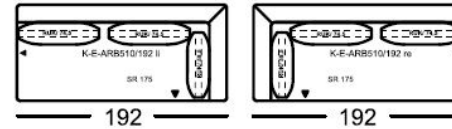

RUK-SET12 2x82 1x59,5

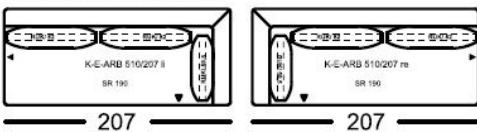

RUK-SET14 2x89,5 1x59,5

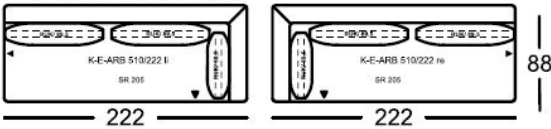

RUK-SET31 2x97 1x59,5

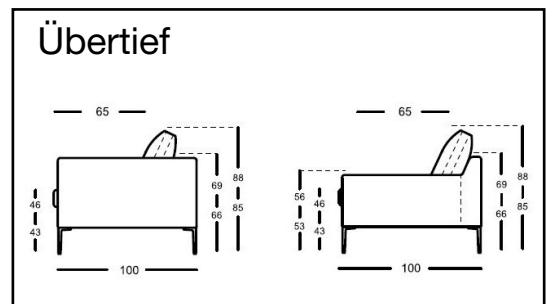
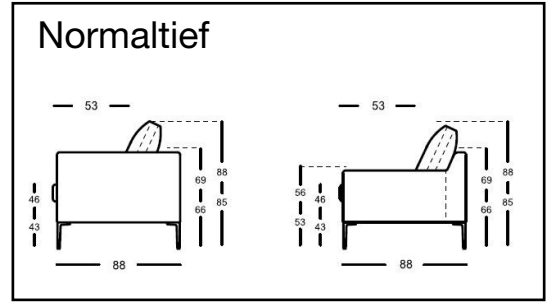
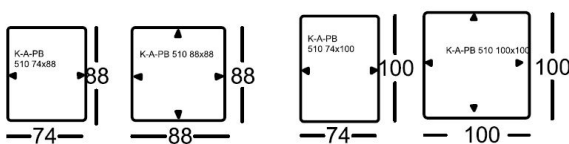
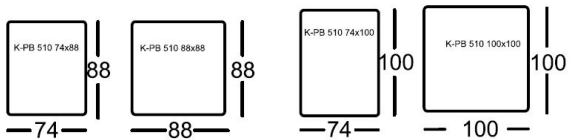
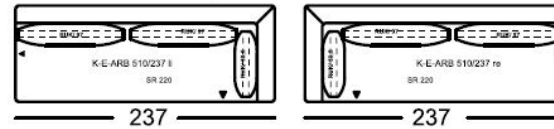

**ROLF
BENZ**

Rückenkissen ohne Abstand

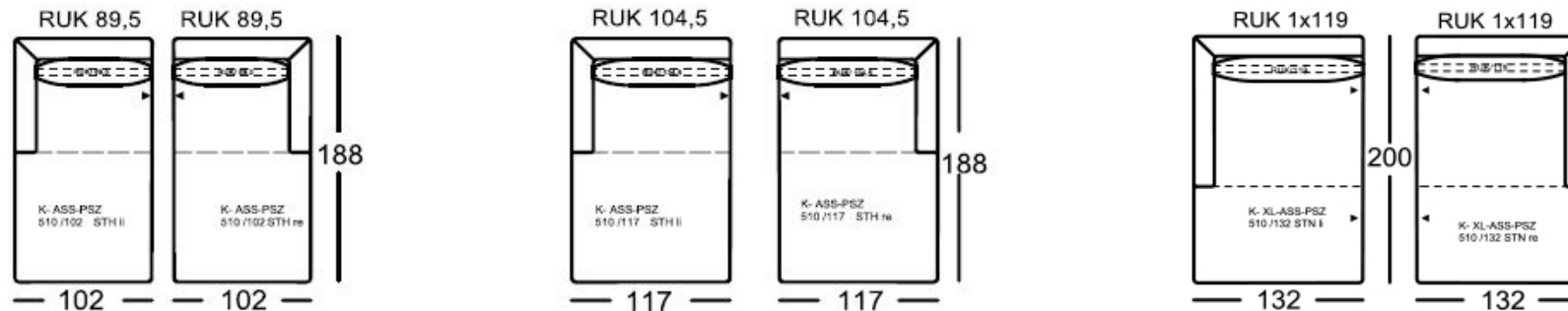
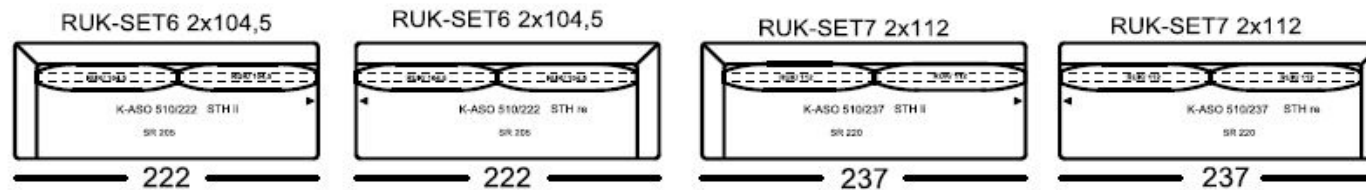
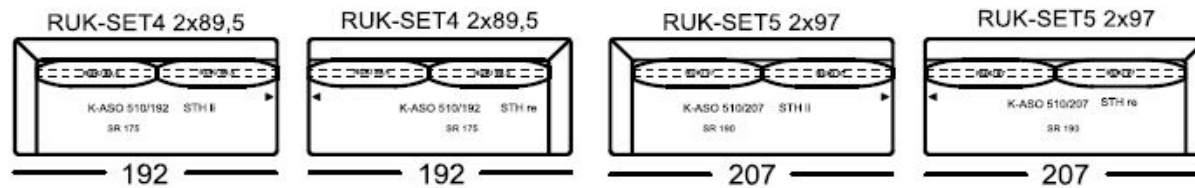
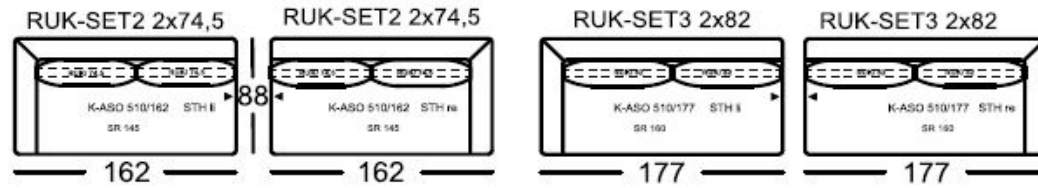
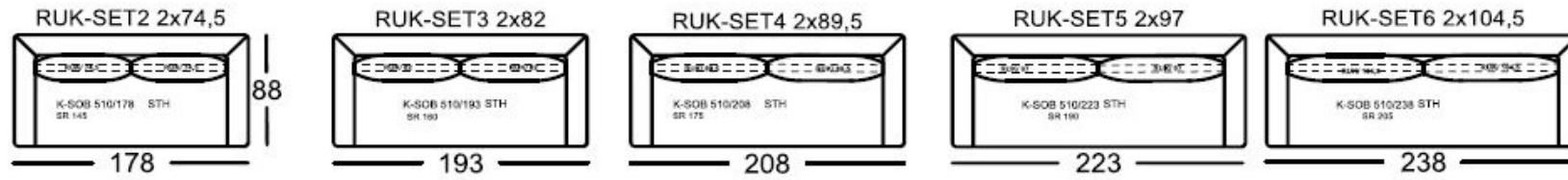

RUK-SET9 2x74,5 1x67

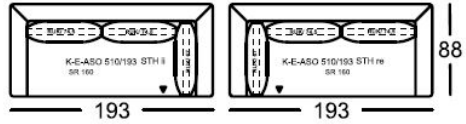

RUK-SET11 2x82 1x67

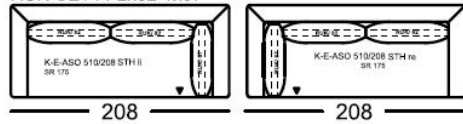

RUK-SET13 2x89,5 1x67

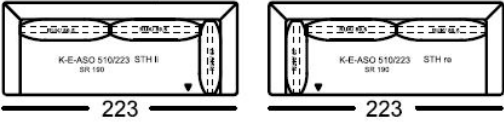

RUK-SET15 2x97 1x67

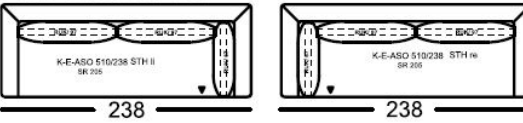

RUK-SET17 3x67

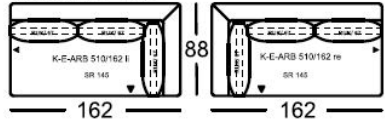

RUK-SET9 2x74 1x67

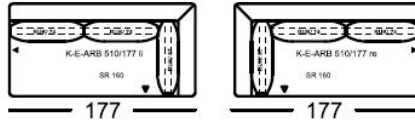

RUK-SET11 2x82 1x67

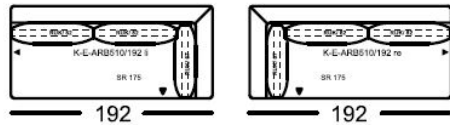

RUK-SET13 2x89,5 1x67

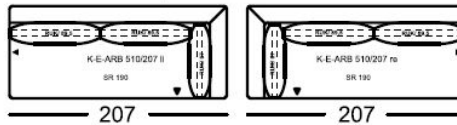

RUK-SET15 2x97 1x67

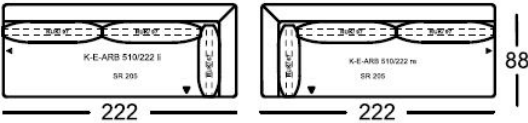

RUK-SET30 2x104,5 1x67

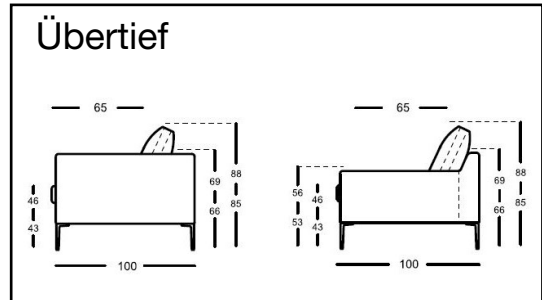
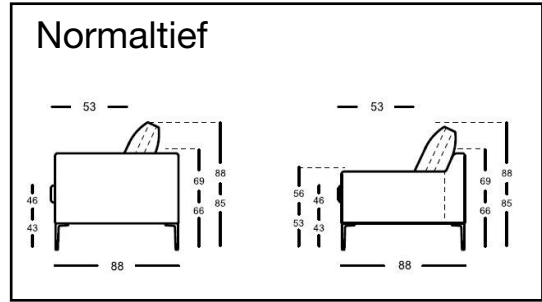
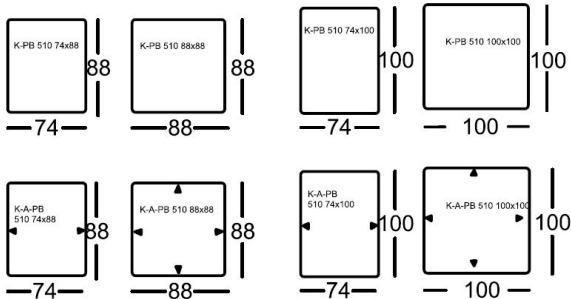
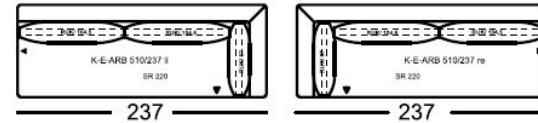

**ROLF
BENZ**

Kombinationsbeispiele:

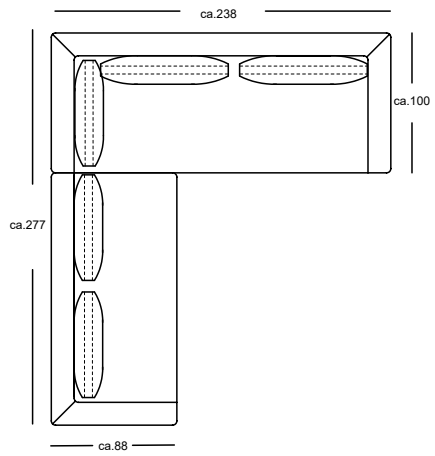

K-ASO 510/177 ISTH i
RUK-SET2 2x74,5

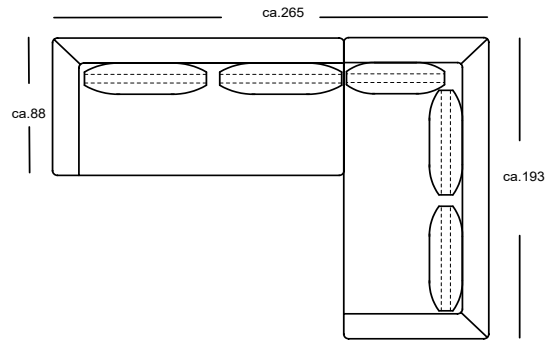

K-ASO 510/177 STH RUK-SET2 2x74,5 K-E-ASO 510/193 STH re RUK-SET8 2x67 1x59,5

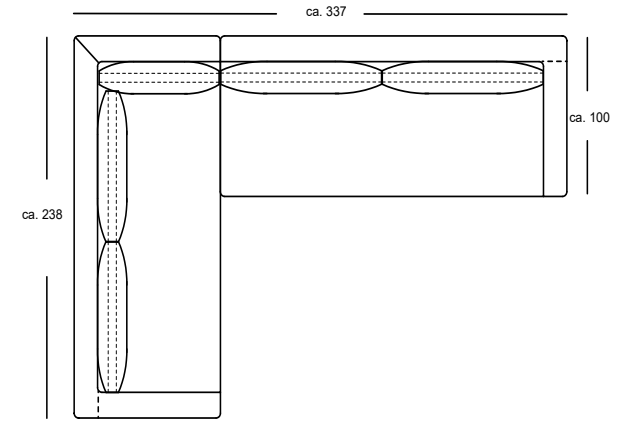

K-UE-E-ASO 510/238STN II RUK-SET25 2x97 1x82 K-UE-ASO 510/237 STN II RUK-SET7 2x112

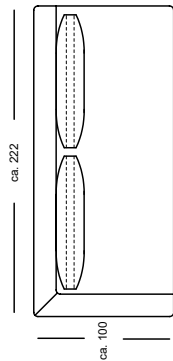
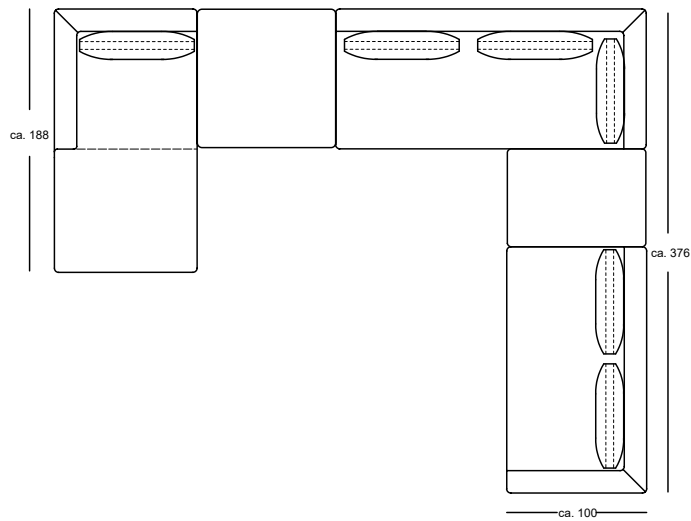

UE-ASO 510/222 STH re

UE- ASS-PSZ 510 /102 STH A-PB 510 99x99 UE-E-ARB 10/222 II A-PB 510 70x99 UE-ASO 510/177 STH re RUK-SETs mit Abstand