

TECHNICAL DATA

# ROLF BENZ MIOKO

---



**ROLF  
BENZ**

- Cast legs, metal, optionally: Fine-grain aluminium, powdercoated, matt:
  - RAL 9017 Traffic black
  - RAL 7022 Umbra grey
  - Marrone metallic
  - RAL 5004 Black blue
  - RAL 7003 Moss grey
  - RAL 8002 Signal brown
  - RAL 7044 Silk grey
  - Polished
- Steel brace, optionally: Steel, fine structure, powdercoated, matt:
  - RAL 9017 Traffic black
  - RAL 7022 Umbra grey
  - Marrone metallic
  - RAL 5004 Black blue
  - RAL 7003 Moss grey
  - RAL 8002 Signal brown
  - RAL 7044 Silk grey
  - Polished chrome
- Seat heights optionally 43 cm or 46 cm

Cast leg



Steel



- Wood inner frame
- Steel shaft spring system
- Seat made of high-quality cold foam, covered with a down-like pad comprising compartments with a filling made of 90 % foam rods and 10 % polyester fibres (Lounge)
- Seat built up in layers with polyurethane foam and a high-quality cold foam, coordinated in different heights and hardnesses, with a polyester fleece covering (Classic)
- Backrest made of polyurethane foam
- Backrest cover quilted with polyester fleece
- Down-like backrest cushions comprising compartments with a filling made of 80 % foam rods and 20 % polyester fibres

Lounge

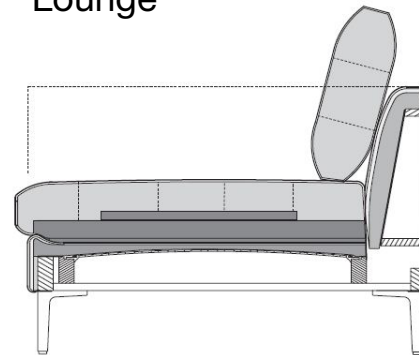

Classic

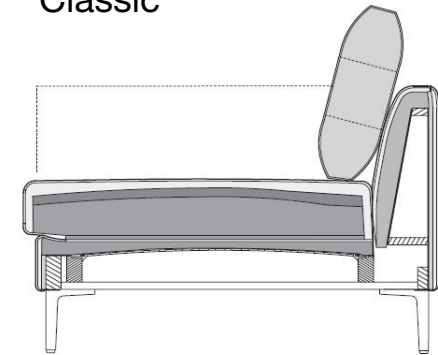

! Due to the way the furniture is designed, and its comfort level, some wrinkles and sitting pressure indentations are inevitable, even in top quality Rolf Benz upholstered furniture. All dimensions are approximate.

# Backrest cushion with a gap

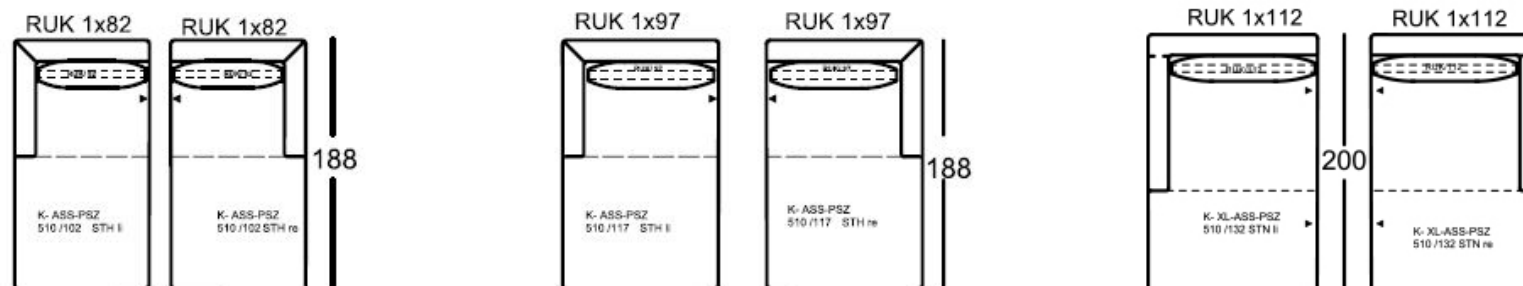
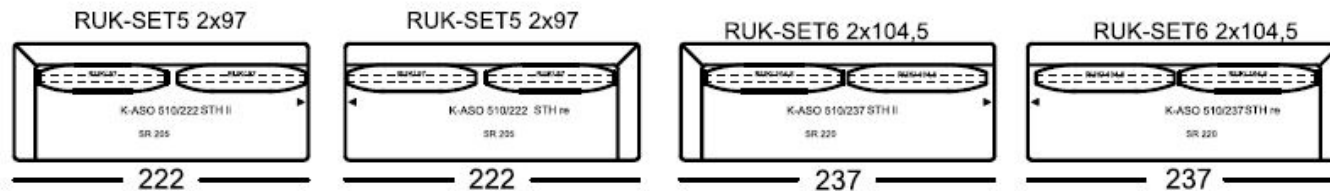
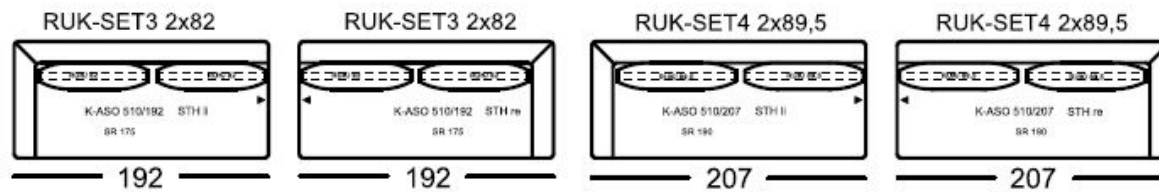
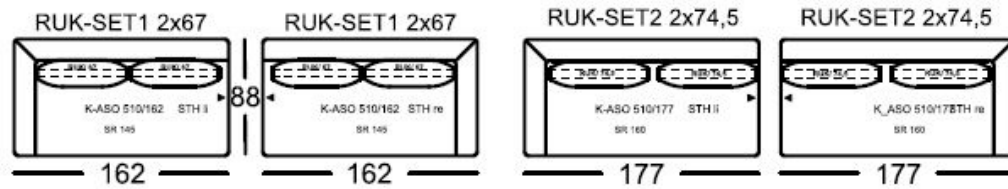
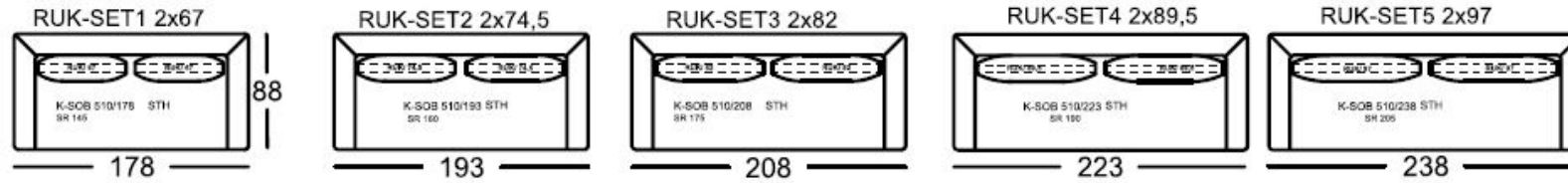

RUK-SET8 2x67 1x59,5

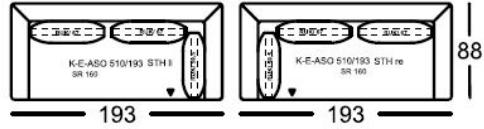

RUK-SET10 2x74,5 1x59,5

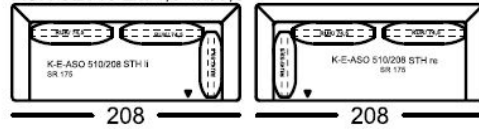

RUK-SET12 2x82 1x59,5

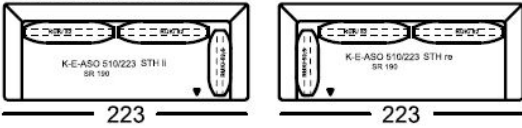

RUK-SET14 2x89,5 1x59,5



RUK-SET16 3x59,5

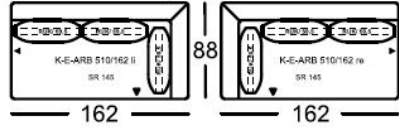

RUK-SET8 2x67 1x59,5

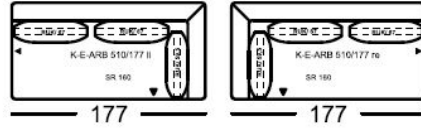

RUK-SET10 2x74,5 1x59,5

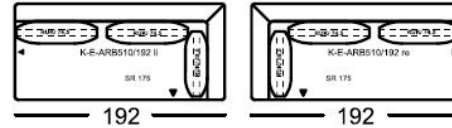

RUK-SET12 2x82 1x59,5

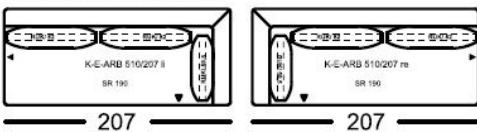

RUK-SET14 2x89,5 1x59,5

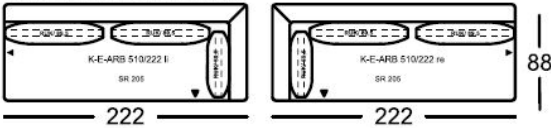

RUK-SET31 2x97 1x59,5

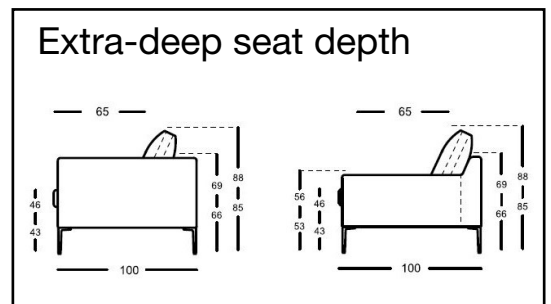
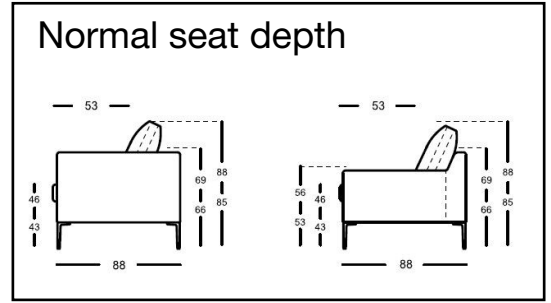
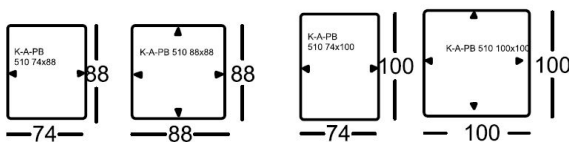
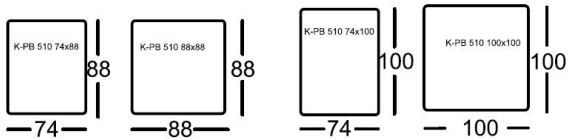
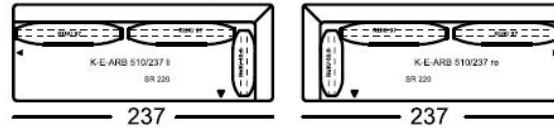

**ROLF  
BENZ**

# Backrest cushion without a gap

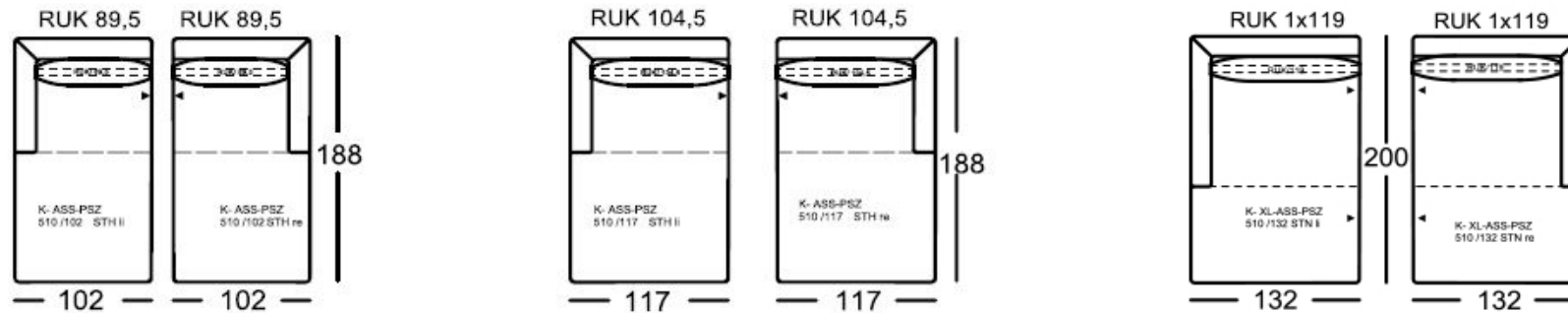
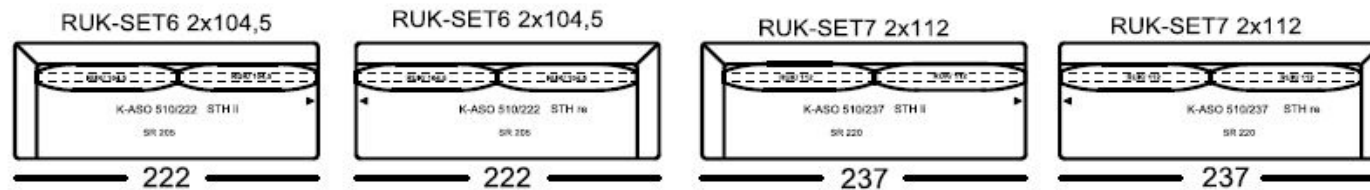
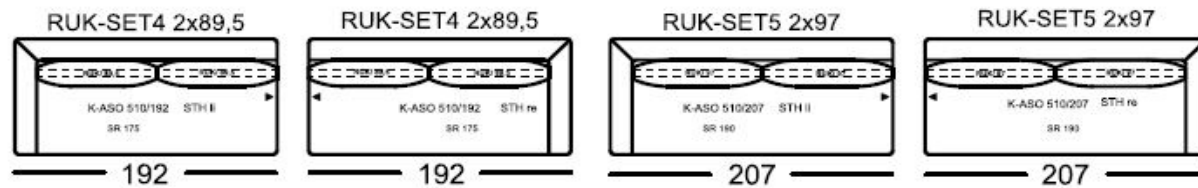
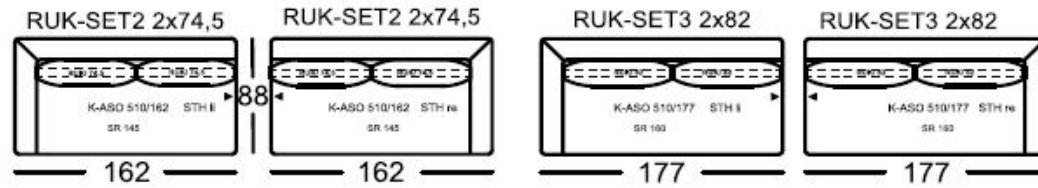
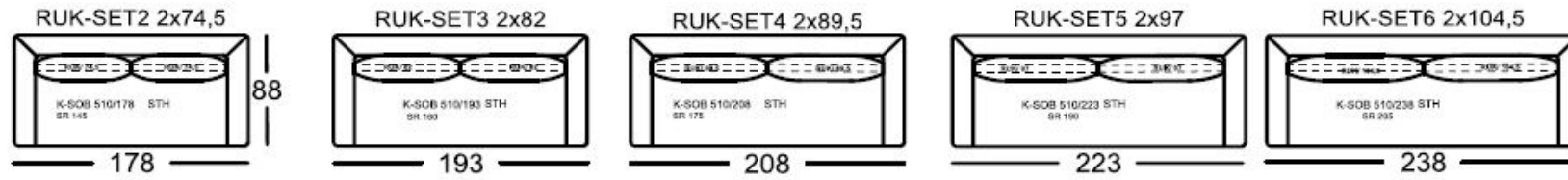



RUK-SET9 2x74,5 1x67

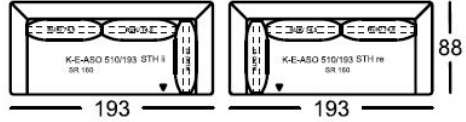

RUK-SET11 2x82 1x67

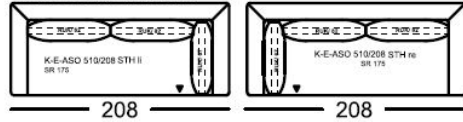

RUK-SET13 2x89,5 1x67

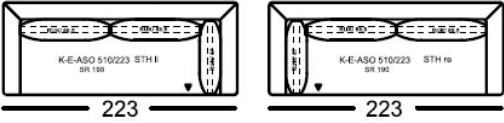

RUK-SET15 2x97 1x67

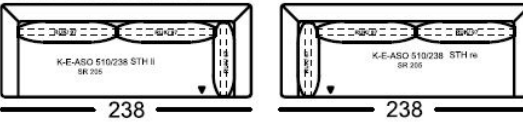

RUK-SET17 3x67

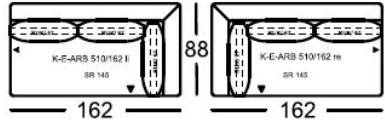

RUK-SET9 2x74 1x67

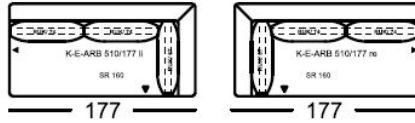

RUK-SET11 2x82 1x67

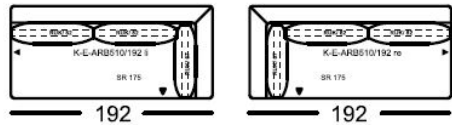

RUK-SET13 2x89,5 1x67

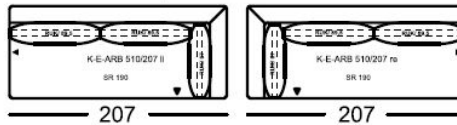

RUK-SET15 2x97 1x67

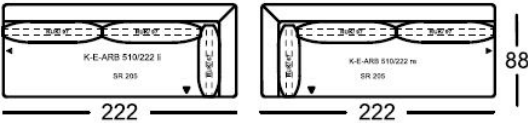

RUK-SET30 2x104,5 1x67

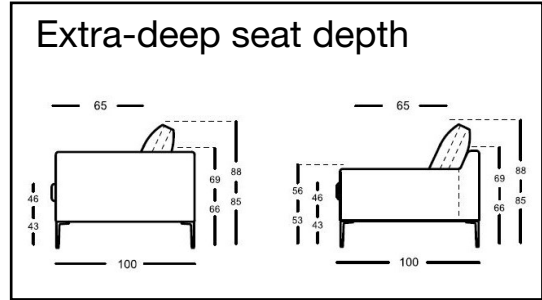
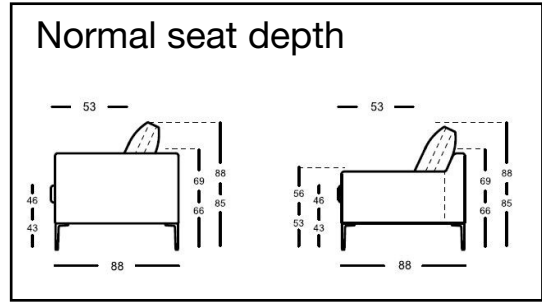
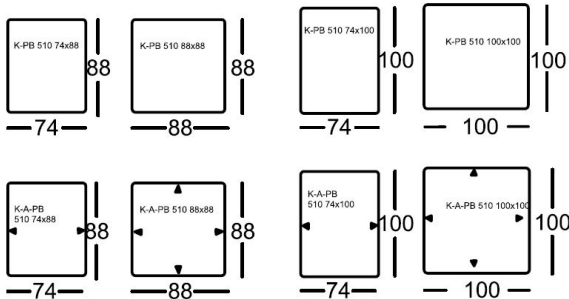
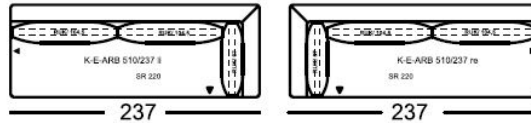

**ROLF  
BENZ**

# Combination examples

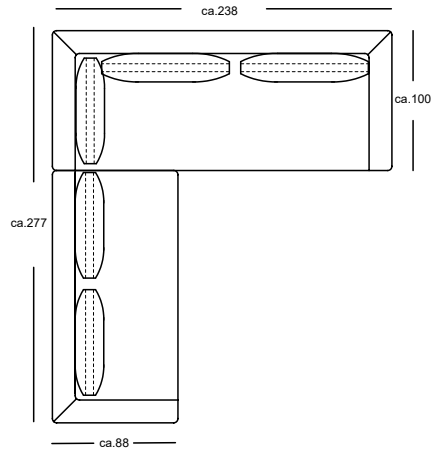

K-ASO 510/177 ISTH i  
RUK-SET2 2x74,5

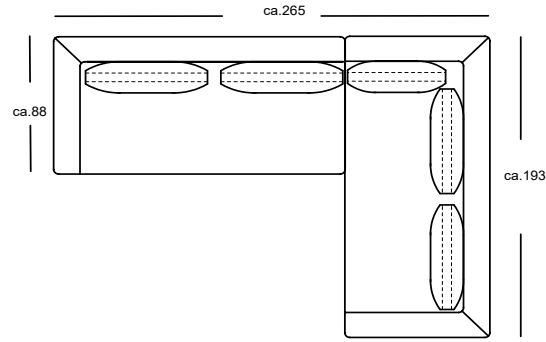

K-ASO 510/177 STH RUK-SET2 2x74,5

K-E-ASO 510/193 STH re RUK-SET8 2x67 1x59,5

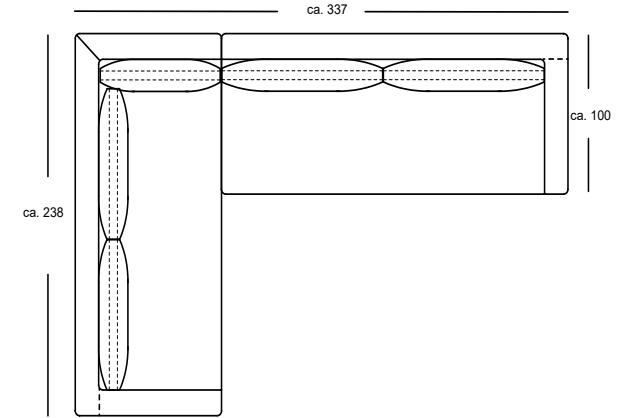

K-UE-E-ASO 510/238STN II RUK-SET25 2x97 1x82

K-UE-ASO 510/237 STN II RUK-SET7 2x112

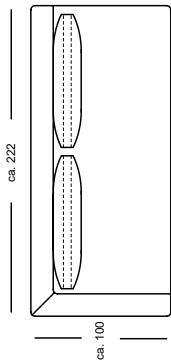
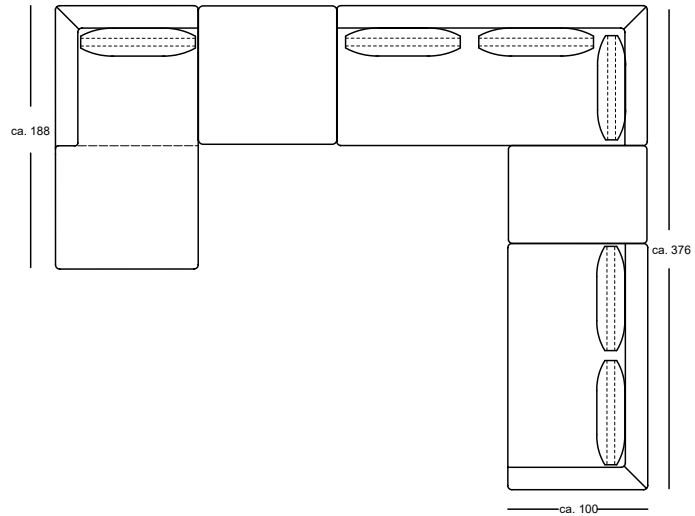

UE-ASO 510/222 STH re

UE- ASS-PSZ 510 /102 STH A-PB 510 99x99 UE-E-ARB 10/222 II A-PB 510 70x99 UE-ASO 510/177 STH re  
RUK-SETs mit Abstand