

TECHNISCHE GEGEVENS

# ROLF BENZ RONDO

---



**ROLF  
BENZ**

- Houten binnenromp
- Nosag veren
- Rugopbouw van polyurethaanschuim
- Rugleuningbekleding met doorgestikt polyestervlies

#### „Lounge Deluxe“

- Zitting van hoogwaardig koudschuim, opgebouwd in lagen, afgedekt met een mat bestaande uit 20% viscoseschuim en 80% microvezels en een hoes van polyestervlies

#### „Lounge Plus“

- Zitting van hoogwaardig koudschuim, opgebouwd in lagen van verschillende dikten en hardheden die op elkaar zijn afgestemd, afgedekt met een hoes van polyestervlies
- Rugkussen met dons karakter, verwerkt in zakjes met een vulling van 100% microvezels
- Zithoogte naar keuze 42 cm of 45 cm
- Poten naar keuze:
  - Poot van gegoten aluminium, gepolijst
  - Poot van gegoten aluminium, gelakt in RAL 9017 verkeerszwart
  - Poot van gegoten aluminium, gelakt in RAL 7022 umbragrijs



Lounge Deluxe

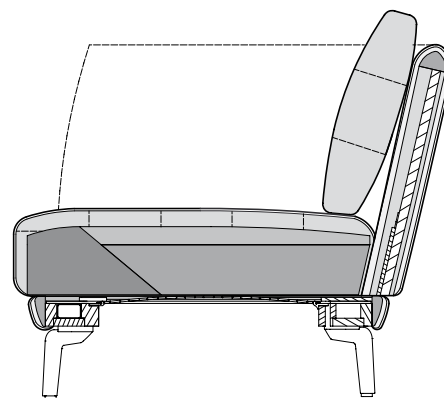

Lounge Plus

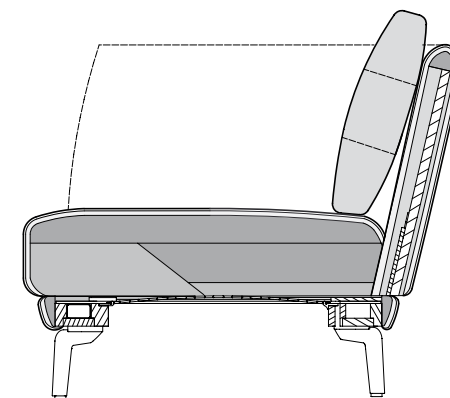

- ! Ploovorming en zitafdrukken zijn vanwege comfort- en designredenen ook bij hoogwaardige gestoffeerde meubels van Rolf Benz niet te vermijden. Alle afmetingen zijn bij benadering.

Zithoogtes leverbaar

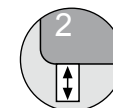

**ROLF  
BENZ**

Bank

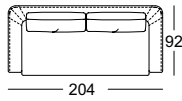

Aanbouwbank\*

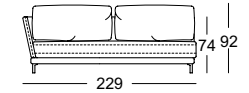
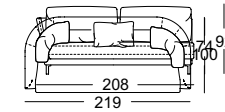
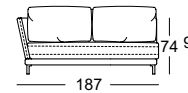
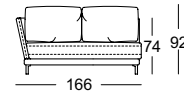
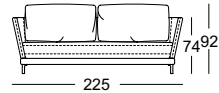
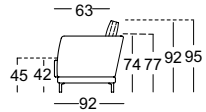

Extra grote  
aanbouwbank\*

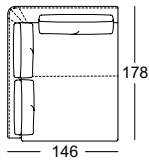

Hoek-aanbouwbank\*



Hoek-aanbouwbank\*

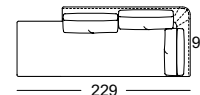

Voetenbank

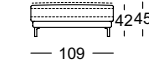
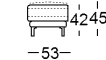
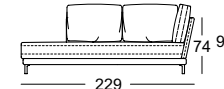
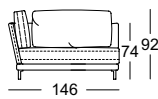
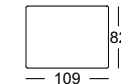

Lage  
rugkussen



Rugkussen-  
matten



Hoofdsteen

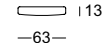

\*Deze elementen zijn als linker uitvoering afgebeeld, ze zijn echter ook in spiegelbeeld, in de rechter uitvoering leverbaar.

**ROLF  
BENZ**

## Combinatievoorbeelden:

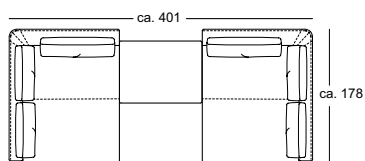

K-XL-ASO 525/146 li.  
RUK-SET-XL-ASO 525/146 li.  
PB 525/109  
K-XL\_ASO 525/146 re.  
RUK-SET-XL-ASO 525/146 re.

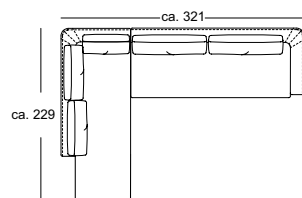

K-E-ARB-PSZ- 525/229 li.  
RUK-SET-E-ARB 525/229  
K-ASO 525/229 re.  
RUK-SET-ASO 525/229

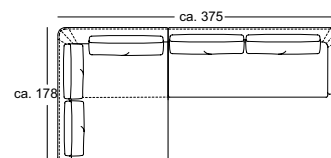

K-XL-ASO 525/146 li.  
RUK-SET-XL-ASP 525/146 li.  
K-ASO 525/229 re  
RUK-SET-ASO 525/229

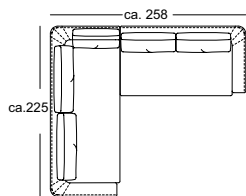

K-E-ASO 525/225 li.  
RUK-SET-E-ASO 525/225 li.  
K-ASO 525/166 re.  
RUK-SET-ASO 525/166

**ROLF  
BENZ**