

FICHES TECHNIQUES

ROLF BENZ TIRA



**ROLF
BENZ**

- Carcasse en métal et bois avec fonction de réglage intégrée
- Garnissage de l'assise et dossier composé de couches de mousse de polyuréthane superposées, de hauteurs et densités différentes, et enrobé d'une housse en non-tissé polyester fixée par encollage.
- Coussin de type couette, garnissage constitué d'un mélange de bâtonnets de mousse et de fibres de polyester
- Hauteur d'assise au choix 40 ou 43 cm
- Structure metal au choix :
 - Acier finement structuré, thermolaqué mat :
 - Gris argent
 - RAL 9017 noir trafic
 - RAL 7022 gris terre d'ombre
 - Acier chrome brillant
- Pour des raisons à la fois de confort et de design, l'apparition de plis et l'effet de miroitementsont deux phénomènes inévitables, même sur les sièges de très haut de gamme portant la griffe Rolf Benz. Toutes les dimensions indiquées sont approximatives.

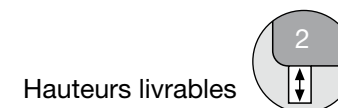
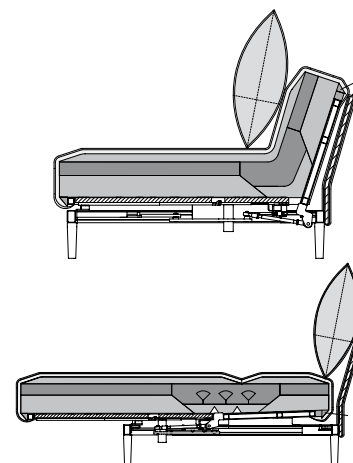

Hauteurs livrables

Canapé lit*

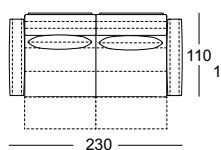

Canapé-lit juxtaposable*

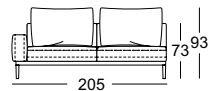
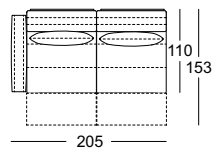

Banquette-lit juxtaposable

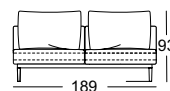
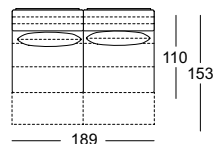

Siège de fin avec pouf et dossier mobile*

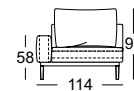
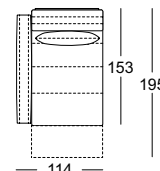

Siège de fin avec accou-
doir*

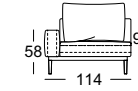
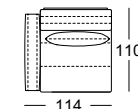

Canapé d'angle composable*
(sans fonction de réglage)

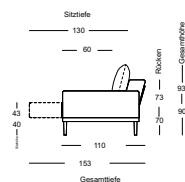
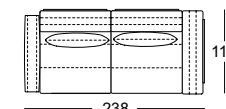

**ROLF
BENZ**

Banquette juxtaposable d'angle*
(sans fonction de réglage)

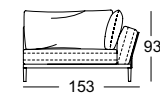
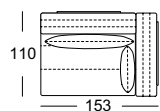

Coussin de dos
juxtaposable



Coussin de dos

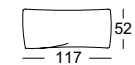
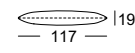
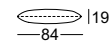

Exemples de composition

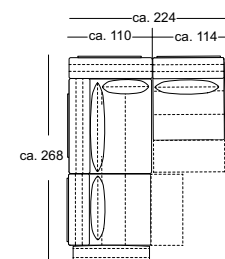
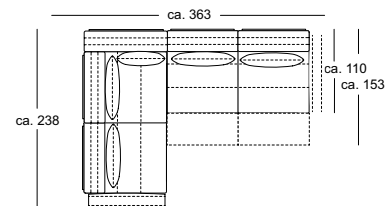
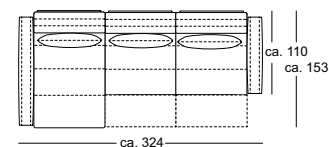
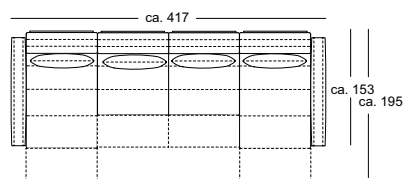

K-L-ASS-PSZ TIRA 114 à g.
K-L-ARB TIRA 189
K-L-ASS-PSZ TIRA 114 à dr.
4x RUK TIRA 84

K-ASS-PSZ TIRA 114 à g.
K-L-ASO TIRA 210 à dr.
3x RUK TIRA 84

K-E-ASO TIRA 238 à g.
K-L-ASO TIRA 210 à dr.
4x RUK TIRA 84
1x RUK TIRA 61

K-L-ASS TIRA 114 à g.
K-E-ARB TIRA 153 à g.
K-L-ASS TIRA 114 à dr.
2x RUK 84
1x RUK 117
1x RK 61

*Ces éléments sont montrés sous une seule forme. Ils existent également en forme inversée.

**ROLF
BENZ**