

TECHNICAL DATA

ROLF BENZ VOLO



**ROLF
BENZ**

- Wooden inner frame
- Spring system: Glass fibre-reinforced plastic female connectors

Seat comfort „Lounge Plus“

- Seat made from layers of high quality cold foam with several variations in thickness and hardness available, with a polyester fleece cover

High-quality, casual upholstery that forms waves/leaves indentations that are typical of the material. All measurements are approximate.

Seat comfort „Lounge Deluxe“

- Seat made of high-quality cold foam, built up in coordinated layers, covered with a mat consisting of 20% viscose foam and 80 % microfibres and a non-woven polyester cover

A high-quality, especially casual upholstery that forms waves/leaves indentations that are typical of the material - this waviness may even occur in new condition. All dimensions are approximate and may deviate by up to around 4 cm, or even more in individual cases where elements are connected.

- Back pad in polyurethane foam
- Back cover quilted underneath with polyester nonwoven
- Upholstery cover glued-on non-woven polyester
- Downy back cushion, in compartments, with filling made from 100 % microfibers
- Seat height options 41 cm or 44 cm
- Cast foot metal: Smooth aluminium, powdercoated, matt, optionally:
- RAL 9017 Traffic black
- RAL 7022 Umbra grey

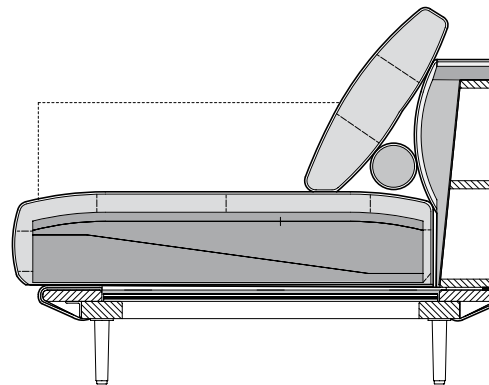
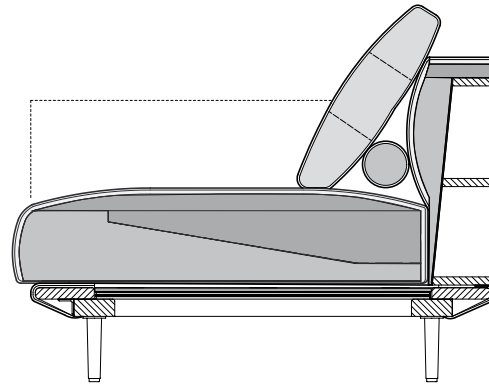

Seat heights available

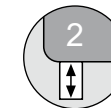

**ROLF
BENZ**

Sofa

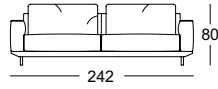
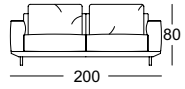

Sectional sofa*

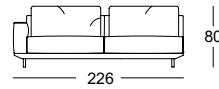
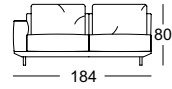
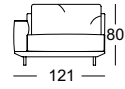

Corner modular sofa element*

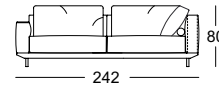

Sectional sofa with upholstered bench element*

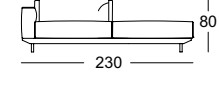
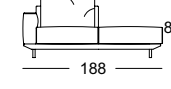

Sectional chair



Closing chair with armrest*

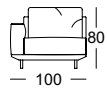

Closing chair with fixed footstool*

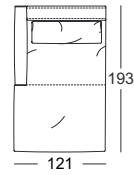

Sectional sofa

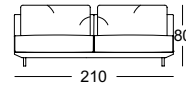
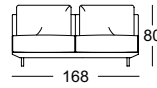
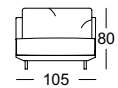

Sectional sofa with upholstered bench element*

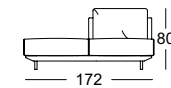
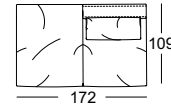

Sectional sofa with footstool*

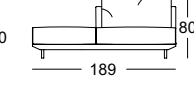
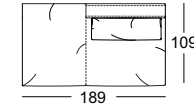

Corner sectional sofa*

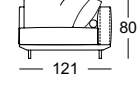

Corner sectional sofa with upholstered bench element*

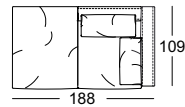

Footstool

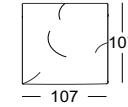
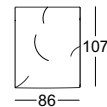

Back cushion low

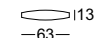

Back cushion



High back cushion

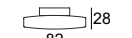

High roll

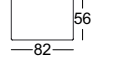
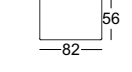
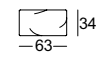
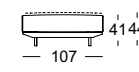
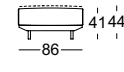
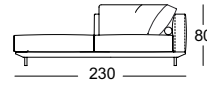
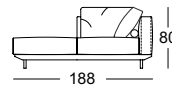
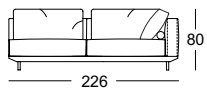
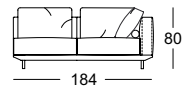

*These elements are only shown in the left version. They are also available in the right version.

Combination examples:

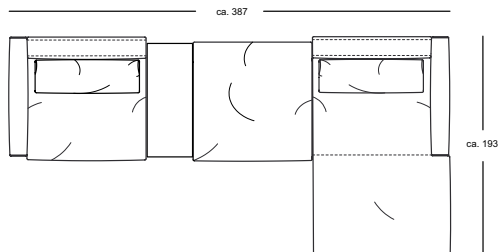

ASO 530/121 le.
Interlocking table 933-113
PSZ 105
ASS-PSZ 530/121 ri.

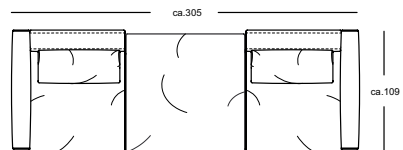

ASS 530/100 le.
PSZ 530/105
ASS 530/100 ri.

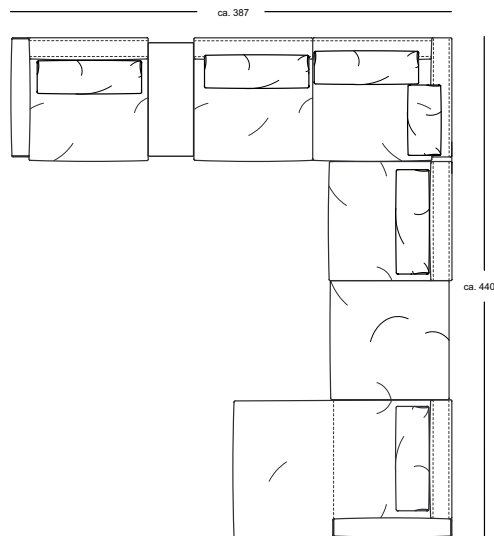

ASO 530/121 le.
Interlocking table 930-113
E-ARB 530/226 le.
ARB 530/105
PSZ 530/105
ASS-PSZ 530/121 ri.

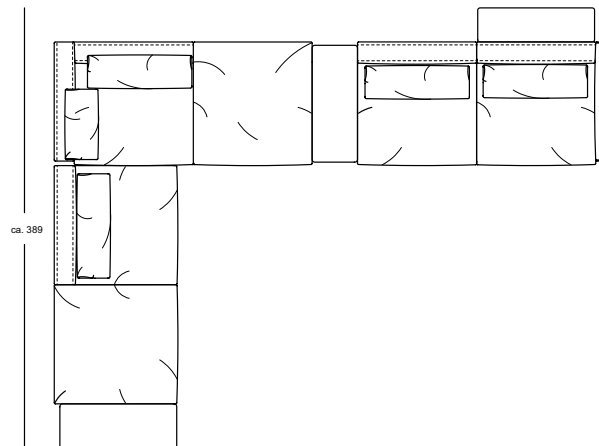

Interlocking table 933-113
ARB_PB 530/210 le.
E-ARB-PB 530/226 ri.
Interlocking table 933-113
ASO 530/226 ri.
Interlocking table 933-213

**ROLF
BENZ**