

TECHNISCHE GEGEVENS

ROLF BENZ VOLO



**ROLF
BENZ**

- Houten binnenromp
- Onderverving: Glasvezelversterkte verende kunststoflatten

Zitcomfort „Lounge Plus“

- Zitting van hoogwaardig koudschuim, opgebouwd in lagen van verschillende dikten en hardheden die op elkaar zijn afgestemd, afgedekt met een hoes van polyestervlies

High-quality, casual upholstery that forms waves/leaves indentations that are typical of the material. All measurements are approximate.

Zitcomfort „Lounge Deluxe“

- Zitting van hoogwaardig koudschuim, opgebouwd in lagen, afgedekt met een mat bestaande uit 20% viscoseschuim en 80% microvezels en een hoes van polyestervlies

Hoogwaardige, bijzonder nonchalante stofferingsopbouw met producttypische vorming van plooiën en zitafdrukken - duidelijker plooibeeld eventueel al in nieuwe toestand. Alle afmetingen zijn circa-maten en kunnen tot ca. 4 cm afwijken - in afzonderlijke gevallen kan dit bij gekoppelde bankstellen zelfs nog meer zijn.

- Rugopbouw van polyurethaanschium
- Rugleuningbekleding met doorgestikt polyestervlies
- Stofferingsafdekking opgelijmd polyestervlies
- Rugkussen met donskarakter, verwerkt in zakjes met een vulling van 100 % microvezels
- Zithoogte naar keuze 41 cm of 44 cm
- Gegoten poot metaal naar keuze:
 - RAL 9017 verkeerszwart
 - RAL 7022 umbragrijs

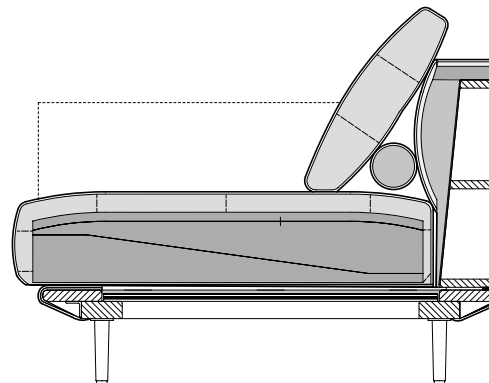
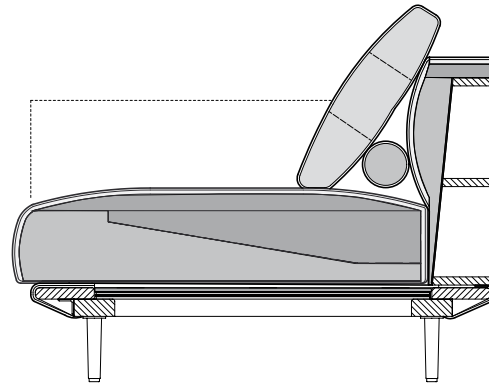

Zithoogtes leverbaar

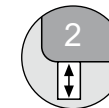

**ROLF
BENZ**

Bank

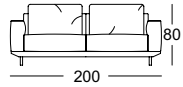

Aanbouwbank*

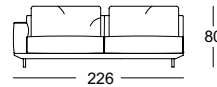
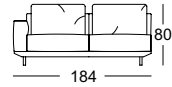
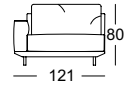
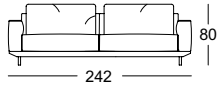

Hoek-aanbouw-
bank*

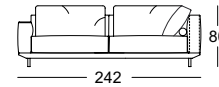

Aanbouwbank met voetenbank*

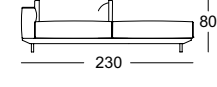
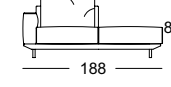

Aanbouw-
eindelement*

Eindelement met
gestofferde zitting
aan de voorkant*

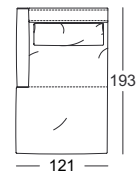

Aanbouwbank met
voetenbank*

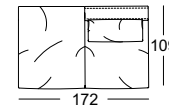

Aanbouwbank met
gestofferde zitting*

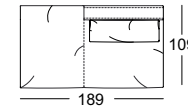

Hoek-aanbouw-
bank*

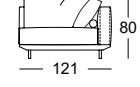
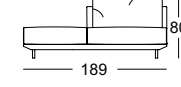
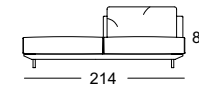
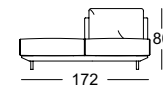
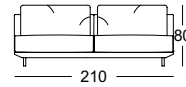
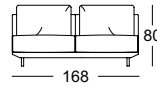
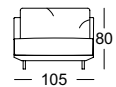
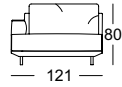
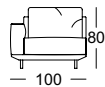

Hoek-aanbouwbank
met voetenbank*

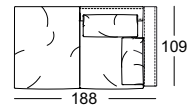

Voetenbankje

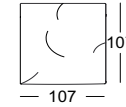
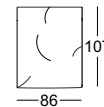

Lage
rugkus-
sen

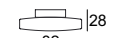
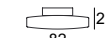

Rug-
kussen
hoog

Rol hoog

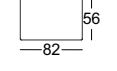
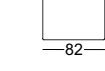
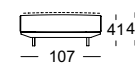
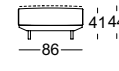
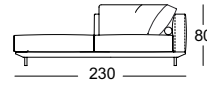
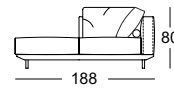
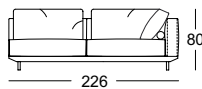
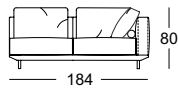

*Deze elementen zijn als linker uitvoering afgebeeld, ze zijn echter ook in spiegelbeeld, in de rechter uitvoering leverbaar.

Combinatievoorbeelden:

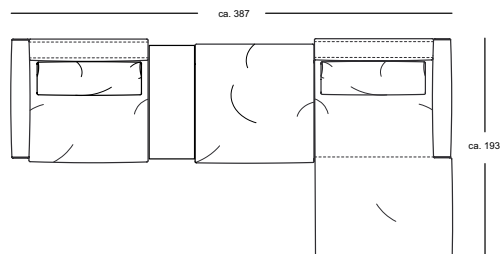

ASO 530/121 li.
Koppeltafel 933-113
PSZ 105
ASS-PSZ 530/121 re,

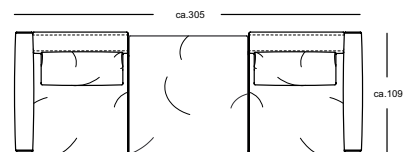

ASS 530/100 li.
PSZ 530/105
ASS 530/100 re.

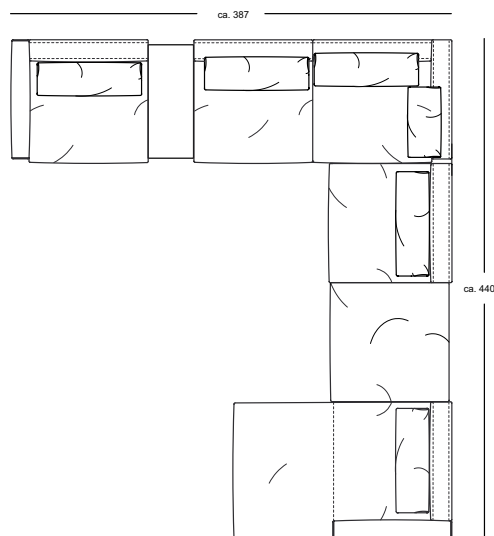

ASO 530/121 li.
Koppeltafel 930-113
E-ARB 530/226 li.
ARB 530/105
PSZ 530/105
ASS-PSZ 530/121 re.

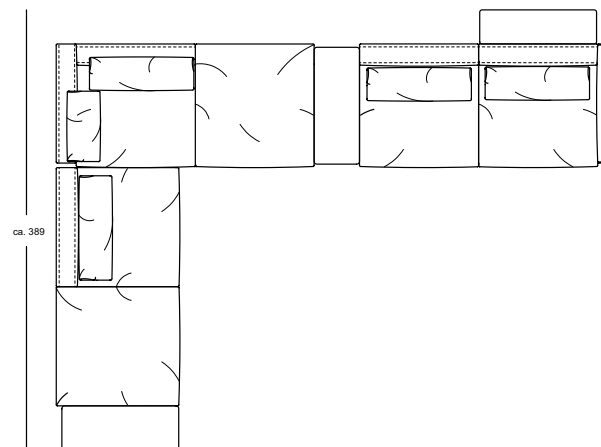

Koppeltafel 933-113
ARB_PB 530/210 li.
E-ARB-PB 530/226 re.
Koppeltafel 933-113
ASO 530/226 re.
Koppeltisch 933-213

**ROLF
BENZ**